



SPINE SURGERY INSTRUMENTS

PRODUCT CATALOGUE



LithosMed

KERRISON RONGEUR

| | |
|--|---|
| Kerrison Punch | 1 |
| Thin Footplate Kerrison Punch | 2 |
| Wide Opening Kerrison Punch | 2 |
| Titanium Dismantable Punch | 4 |
| Curved Foraminotomy Punch | 4 |
| Long Anterior Kerrison Punch | 5 |
| Bayonet Kerrison Punch | 5 |
| Ferris-Smith Kerrison Punch Ring Handled | 6 |
| Blackline Kerrison Punch | 6 |

DISC RONGEURS

| | |
|------------------------------------|----|
| Intervertebral Disc Rongeur | 7 |
| Caspar Disc Rongeur | 7 |
| Schlesinger Toothed Rongeur | 7 |
| Williams Disc Rongeur | 8 |
| 'Pea Pod' Disc Rongeur | 8 |
| Beck Disc Rongeur | 8 |
| Munich Grasping Forceps | 9 |
| Weil-Blakesley Forceps | 9 |
| Decker Rongeur | 9 |
| Nicola Micro Cupped Biopsy Forceps | 9 |
| Micro Disc Rongeur | 10 |
| Micro Toothed Disc Rongeur | 10 |
| Cushing Disc Rongeur | 10 |
| Toothed Fine Disc Rongeur | 10 |
| Ferris-Smith Rongeur | 11 |
| Anterior Disc Rongeur | 11 |

BONE NIBBLERS & CUTTERS

| | |
|--------------------------------------|----|
| Lempert Bone Nibbler | 12 |
| Luer Bone Nibbler | 12 |
| Adson Bone Nibbler | 12 |
| Pennybacker Bone Nibbler | 13 |
| Northfields Bone Nibbler | 13 |
| 'Rat Toothed' Bone Nibbler | 13 |
| Zielke Intervertebral Rongeur | 14 |
| Matzen Rongeur | 14 |
| Beyer Bone Nibbler | 14 |
| Jansen Bone Nibbler | 15 |
| Marquardt Bone Nibbler | 15 |
| Smith-Peterson Bone Nibbler | 15 |
| Leksell Bone Nibbler | 15 |
| Stille-Luer Bone Nibbler | 16 |
| 'Mr Blobby' Stille-Luer Bone Nibbler | 16 |
| Echlin Duckbill Nibbler | 16 |
| Long Anterior Leksell Bone Nibbler | 17 |
| Sypert Bone Nibbler | 17 |
| McIndoe Bone Cutters | 18 |
| Stille-Liston Bone Cutters | 18 |
| Liston-Key-Horsley Bone Cutters | 18 |
| Tudor Edwards/Vehmehren Costotome | 18 |

OSTEOTOMES & MALLETS

| | |
|----------------------------|---------|
| Capener Osteotome | 19 |
| Lexer Osteotome | 19 |
| Dahmen Osteotome | 19 |
| Scaglietti Osteotome | 19 |
| Lambotte Osteotome | 20 |
| Stille (Swedish) Osteotome | 20 |
| Hibbs Osteotome | 20 |
| Smith Petersen Osteotome | 20 |
| Mallets | 21 & 22 |

ELEVATORS & GOUGES

| | |
|----------------------|---------|
| Cobb Elevators | 23 & 24 |
| Adson Elevator | 25 |
| Pennybacker Elevator | 25 |
| Bone Raspatory | 25 |
| Farabeuf Elevator | 25 & 26 |
| Trethowan Elevator | 27 |
| Bristow Elevator | 27 |
| Zielke Gouge | 27 |
| Capener Gouge | 27 |

DISSECTORS

| | |
|------------------------------|----|
| Swedish Dissector | 28 |
| Howarth Elevator | 28 |
| MacDonald Elevator/Dissector | 28 |
| Watson Cheyne Dissector | 28 |
| Freers Elevator/Dissector | 28 |

BONE GRAFT IMPACTORS

| | |
|--------------------------------|----|
| Cervical Impactor | 29 |
| Lumbar Impactor | 29 |
| Anterior Impactor | 29 |
| Caspar Dowel Holder & Impactor | 29 |

SPINAL CURETTES

| | |
|---------------------------------|---------|
| Bayonet Cervical Micro Curettes | 30 & 31 |
| Lempert Curette | 32 |
| Bruns Curette | 32 |
| Tufnol Handle Curette | 32 |
| Cobb Bone Curette | 33 |
| Comfort Handle Curette | 33 |
| Long Anterior Curette | 33 |
| Light-Grip Cervical Curette | 34 |
| Light-Grip Lumbar Curette | 35 |
| Cones Curette | 36 |
| Karl Ring Curette | 36 |
| Zielke Curette | 37 |
| Volkman Curette | 37 |

CASPAR CERVICAL DISTRACTION SET

| | |
|-------------------------------|----|
| Vertebral Body Distractor Set | 38 |
| Distraction Retractors | 38 |
| Drill Guide | 39 |
| Screw Driver | 39 |
| Distraction Drill | 39 |
| Caspar Distraction Screw | 39 |

LAMINA AND VERTEBRAL SPREADER

| | |
|-------------------------------|----|
| Cervical Vertebral Spreader | 40 |
| Cloward Vertebral Spreader | 40 |
| Cloward Lamina Spreader | 41 |
| Baby Inge Lamina Spreader | 41 |
| Scaglietti Lamina Spreader | 41 |
| Inge Lamina Spreader | 42 |
| Long Anterior Lamina Spreader | 42 |

HOOKS AND PROBES

| | |
|-----------------------------------|----|
| Pedicle Probes | 43 |
| Adson Dura Hook | 43 |
| Weary Blunt Nerve Hook | 43 |
| Crile Blunt Hook | 43 |
| Emmet Sharp Hook | 43 |
| Cushing Blunt Hook | 44 |
| Adson Hook | 44 |
| Ball Tipped Probe | 44 |
| Ball Tipped Probe-Fine Pattern | 45 |
| Manipulation Hook | 45 |
| Blalock Blunt Hook | 45 |
| Caspar Exploration Hook Insulated | 45 |

RHOTON MICRO DISSECTOR

| | |
|----------------------------------|-------|
| Titanium Micro Round Dissector | 46 |
| Titanium Micro Elevator | 46 |
| Titanium Micro Spatula Dissector | 46 |
| Titanium Micro Hook | 46 |
| Titanium Micro Curette | 47 |
| Titanium Micro Ball Dissector | 47 |
| Complete Rhoton Dissector Set | 47&48 |

RETRACTORS

| | |
|--------------------------------------|-------|
| Nerve Root Retractors | 49-51 |
| Hand Held Retractors | 52-54 |
| Self Retaining Retractors | 55-60 |
| McCulloch Retractor Set | 61-63 |
| McCulloch Style Micro Discectomy Set | 64-66 |
| Black Belt Retractor Set | 67-70 |

RETRACTORS

| | |
|--|-------|
| Super Slide II Laminectomy Retractor Set | 71-73 |
| Caspar Micro Lumbar Retractor Set | 74-77 |
| Piccolino Mini Lumbar Retractor Set | 78-79 |
| BlackBelt Micro Discectomy Retractor Set | 80-81 |

LUMBAR SPINAL SET

| | |
|-------------------|-------|
| Lumbar Spinal Set | 82-84 |
|-------------------|-------|

BAYONET MICRO INSTRUMENTS

| | |
|---------------------------|-------|
| Bayonet Micro Instruments | 85-87 |
|---------------------------|-------|

BIPOLAR FORCEP

| | |
|----------------|-------|
| Bipolar Forcep | 88-89 |
| Bipolar Cables | 90 |

MISC INSTRUMENTS

| | |
|-----------------------------------|----|
| Slim and Square Ended Wire Pilers | 91 |
| Muller Claus Wire Cutters | 91 |
| Combined Wire Cutters and Piler | 91 |
| Bolt Cutter With Dismantable Arm | 92 |
| Orthopaedic Locking Pilers | 92 |
| Needle Nosed Locking Pilers | 92 |
| Measuring Caliper | 93 |
| Castroviejo Caliper | 93 |
| Vernier Caliper | 93 |
| Depth Gauge | 94 |
| Direct Reading Depth Gauge | 94 |
| Frazier Suction T | |
| Bayonet Dissecting Forceps | 95 |



Website: www.lithosmed.com

Email: Lithosmed@gmail.com

Telephone: +2347053666407

KERRISON RONGEUR



| Bite | 1mm | 2mm | 3mm | 4mm | 5mm | 6mm |
|---------------|----------------|-----|-----|----------------|-----|-----|
| Jaw Dimension | 18cm/7'' Shaft | | | 20cm/7'' Shaft | | |

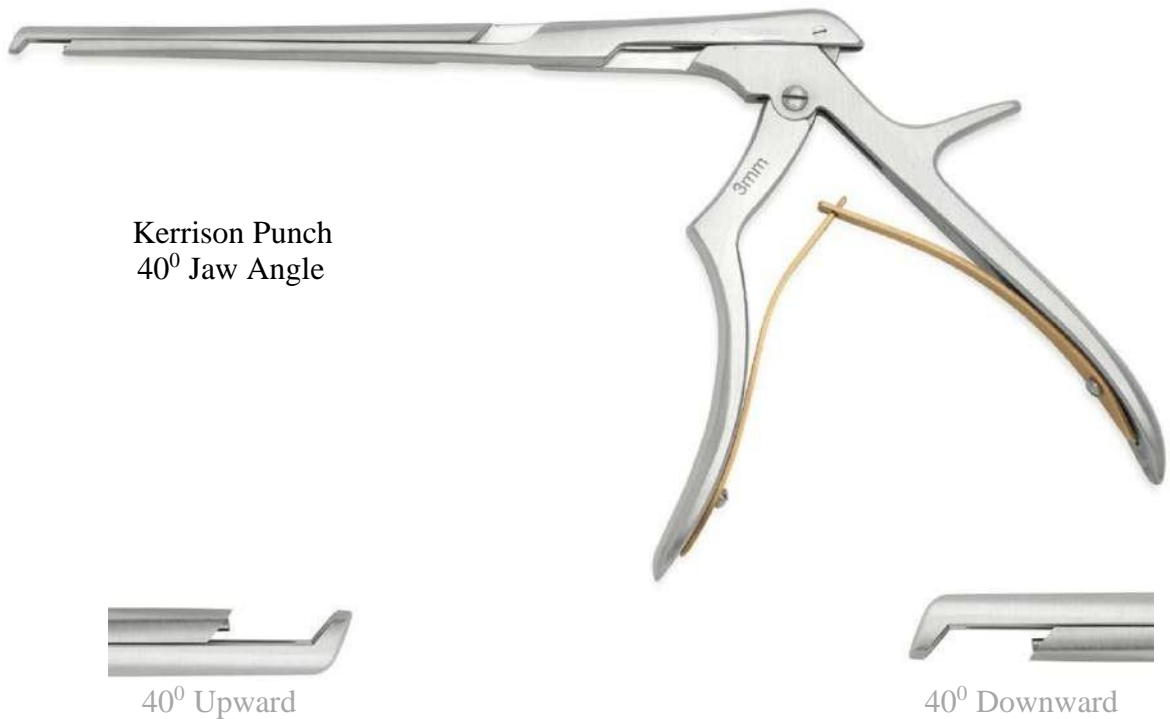

| Bite | 1mm | 2mm | 3mm | 4mm | 5mm | 6mm |
|---------------|----------------|-----|-----|----------------|-----|-----|
| Jaw Dimension | 18cm/7'' Shaft | | | 20cm/7'' Shaft | | |



.....Bridging the gap to qualitative healthcare



Website: www.lithosmed.com

Email: Lithosmed@gmail.com

Telephone: +2347053666407

KERRISON RONGEUR

Thin Footplate Kerrison For Cervical Surgery
40°/90°
Upward/Downward Jaw Angle

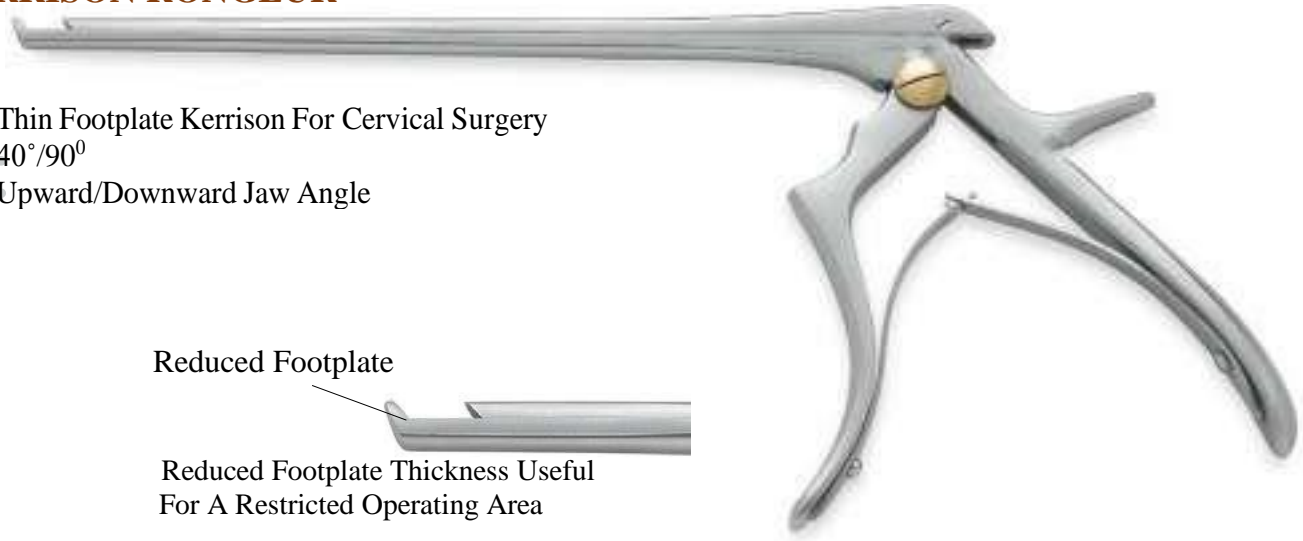

Reduced Footplate

Reduced Footplate Thickness Useful For A Restricted Operating Area

Thin Footplate Kerrison Punch

| Bite | 1mm | 2mm | 3mm | 4mm | 5mm | 6mm |
|-----------------|---------------|-----|-----|---------------|-----|-----|
| Jaw Dimension | 18cm/7" Shaft | | | 20cm/7" Shaft | | |
| Jaw Angulation | 40° | | | 90° | | |
| Working Profile | Downward | | | Upward | | |

Wide Opening Kerrison Punch
40° Upward Jaw Angle
16mm Wide Opening
JawBone Ejector



- Wide opening jaws allowing the surgeon to envelope more bone

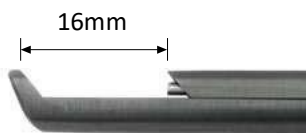

| Bite | 1mm | 2mm | 3mm | 4mm | 5mm | 6mm |
|-----------------|---------------|-----|-----|---------------|-----|-----|
| Jaw Dimension | 18cm/7" Shaft | | | 20cm/7" Shaft | | |
| Jaw Angulation | 40° | | | 90° | | |
| Working Profile | Downward | | | Upward | | |





Website: www.lithosmed.com

Email: Lithosmed@gmail.com

Telephone: +2347053666407

KERRISON RONGEUR

Blackline Kerrison Punch

- 40° Upward Jaw Angle
- Special Titanium Coating
- Bone Ejector



40° Upward

| Bite | 1mm | 2mm | 3mm | 4mm | 5mm | 6mm |
|-----------------|----------------|-----|-----|----------------|-----|-----|
| Jaw Dimension | 18cm/7'' Shaft | | | 20cm/7'' Shaft | | |
| Jaw Angulation | 40° | | | 90° | | |
| Working Profile | Downward | | | Upward | | |

Kerrison Punch

- Bone Ejector
- 40° Upward Jaw Angle



| Bite | 1mm | 2mm | 3mm | 4mm | 5mm | 6mm |
|-----------------|----------------|-----|-----|----------------|-----|-----|
| Jaw Dimension | 18cm/7'' Shaft | | | 20cm/7'' Shaft | | |
| Jaw Angulation | 40° | | | 90° | | |
| Working Profile | Downward | | | Upward | | |





Website: www.lithosmed.com

Email: Lithosmed@gmail.com

Telephone: +2347053666407

KERRISON RONGEUR

Titanium Kerrison Dismantlable Punch

Titanium Coating

Take Apart for Cleaning Bone Ejector

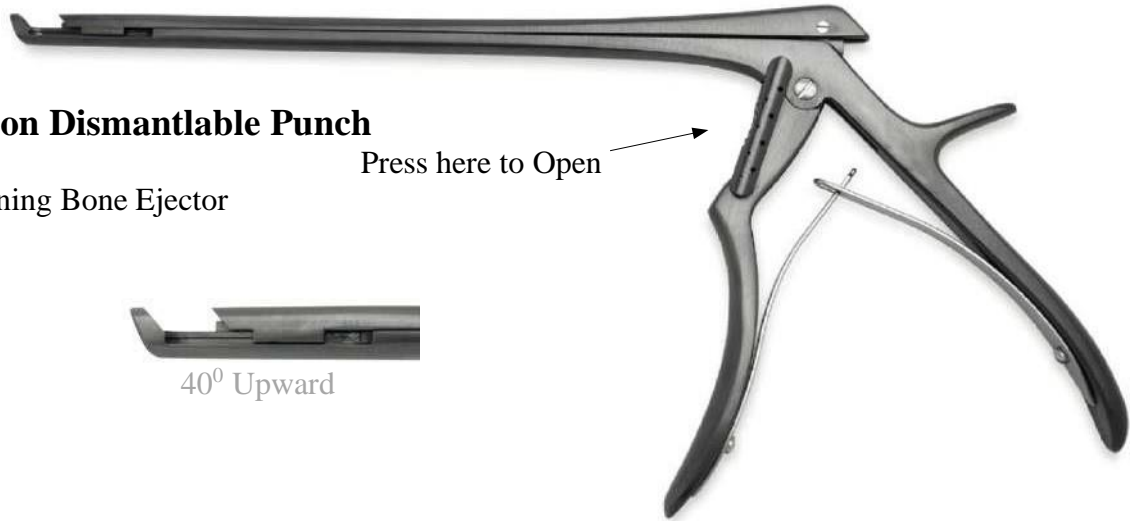

40° Upward

| Bite | 1mm | 2mm | 3mm | 4mm | 5mm | 6mm |
|-----------------|---------------|-----|-----|---------------|-----|-----|
| Jaw Dimension | 18cm/7" Shaft | | | 20cm/7" Shaft | | |
| Jaw Angulation | 40° | | | 90° | | |
| Working Profile | Downward | | | Upward | | |

Curved Foraminotomy Punch

- Curved Shaft designed to improve access to the Foramen



40° Upward

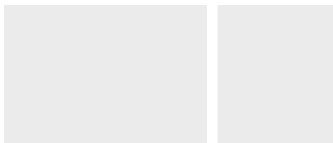

| Bite | 2mm | 3mm | 4mm |
|----------------|---------------|-----|-----|
| Jaw Dimension | 18cm/7" Shaft | | |
| Jaw Angulation | 40° | | |



.....Bridging the gap to qualitative healthcare



KERRISON RONGEUR

Long Anterior Laminectomy Punch

- Special Titanium Coating
- Extra Long Shaft for Thoracic Approach
- Bone Ejector

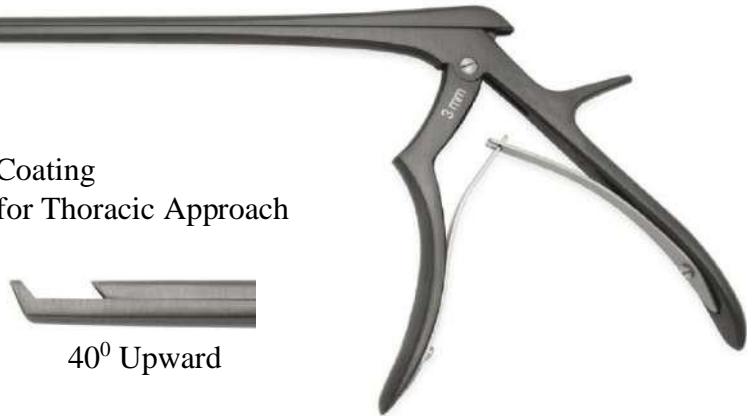

| Bite | 1mm | 2mm | 3mm | 4mm | 5mm | 6mm |
|-----------------|---------------|-----|-----|---------------|-----|-----|
| Jaw Dimension | 18cm/7" Shaft | | | 20cm/7" Shaft | | |
| Jaw Angulation | 40° | | | 90° | | |
| Working Profile | Downward | | | Upward | | |

Bayonet Kerrison Rongeur

- Angle allows for improved visibility
- Special Titanium Coating on surface
- Bone Ejector

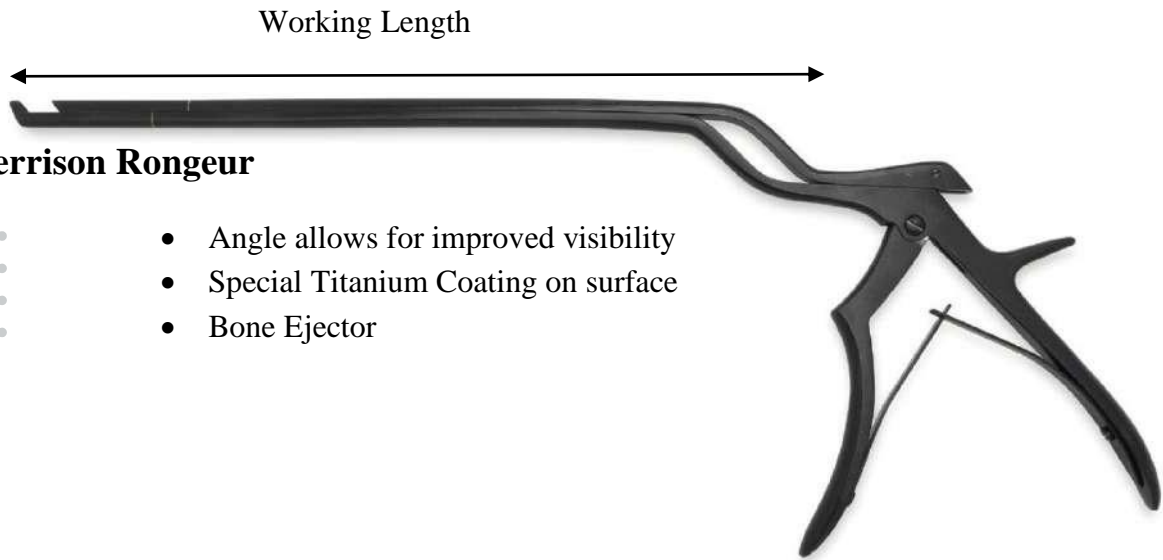

| Bite | 1mm | 2mm | 3mm | 4mm | 5mm | | |
|-----------------|------|---------------|-----|-----|---------------|--|--|
| Jaw Dimension | 20cm | 23cm/7" Shaft | | | 28cm/7" Shaft | | |
| Jaw Angulation | | 40° | | | 90° | | |
| Working Profile | | Downward | | | Upward | | |
| Working Length | 12cm | 18cm | | | 20cm | | |





Website: www.lithosmed.com

Email: Lithosmed@gmail.com

Telephone: +2347053666407

KERRISON RONGEUR



Ferris Smith Kerrison Rongeur

- Modified Ring Handle



40° Upward

| Bite | 1mm | 2mm | 3mm | 4mm | 5mm | 6mm |
|-----------------|---------------|-----|-----|---------------|-----|-----|
| Jaw Dimension | 18cm/7" Shaft | | | 20cm/7" Shaft | | |
| Jaw Angulation | 40° | | | 90° | | |
| Working Profile | Upward | | | | | |





Website: www.lithosmed.com

Email: Lithosmed@gmail.com

Telephone: +2347053666407

DISC RONGEUR

Intervertebral Disc Rongeur

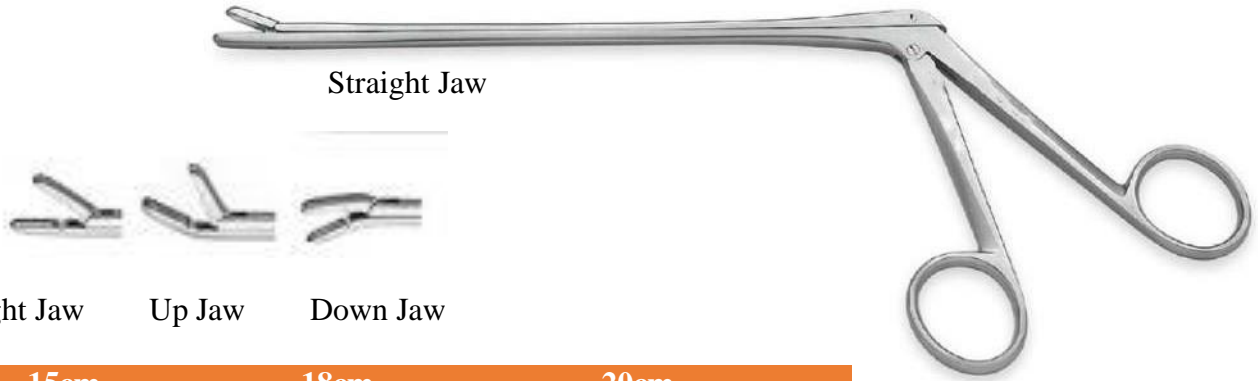

Straight Jaw

Straight Jaw Up Jaw Down Jaw

| Shaft | 15cm | | | 18cm | | | 20cm | | |
|-------|--------------|-------|-----|------------|-----|-----|--------------|-----|--|
| Bite | 1mm | 1.5mm | 2mm | 3mm | 4mm | 5mm | 6mm | 7mm | |
| Jaw | Straight Jaw | | | Upward Jaw | | | Downward Jaw | | |

Caspar Toothed Disc Rongeur

Serrated And Fenestrated Jaws

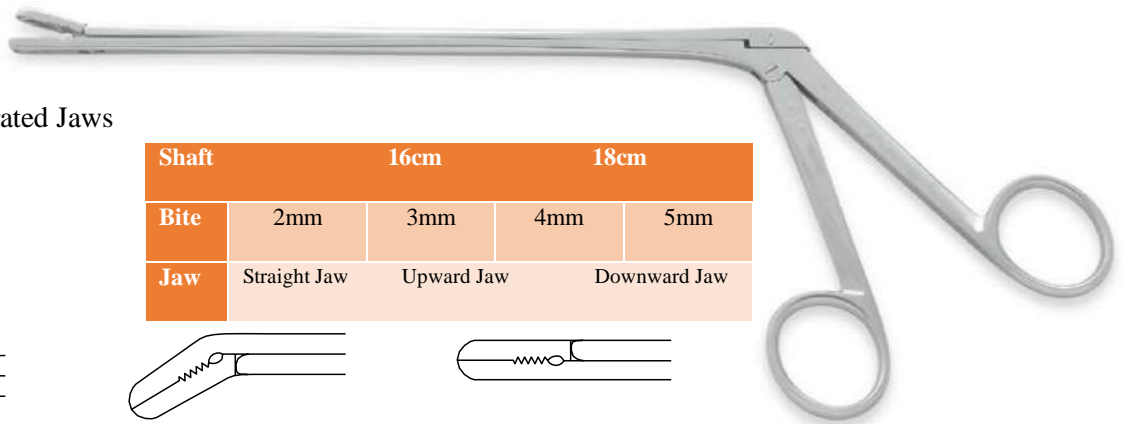

| Shaft | 16cm | | | 18cm | |
|-------|--------------|------------|--------------|------|--|
| Bite | 2mm | 3mm | 4mm | 5mm | |
| Jaw | Straight Jaw | Upward Jaw | Downward Jaw | | |

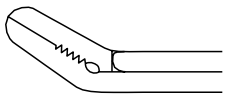

Upward Jaw

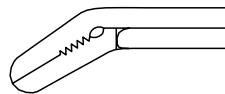

Downward Jaw

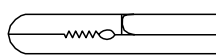

Straight Jaw

Schlesinger Toothed Rongeur

Fine Serration On The Jaw Edge

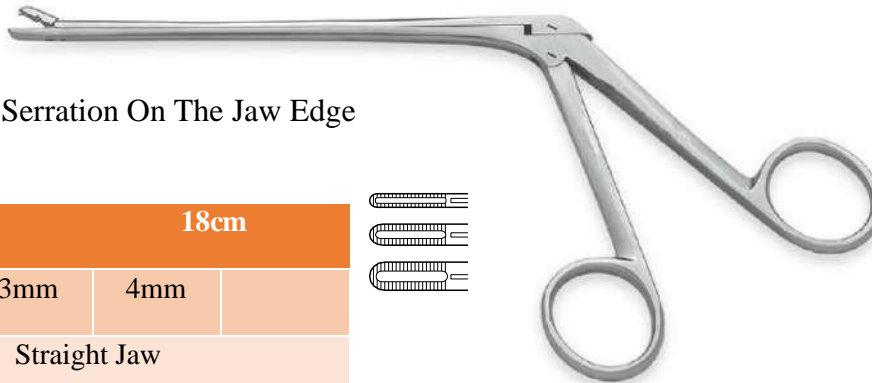

| Shaft | 15cm | | | 18cm | |
|-------|--------------|-----|-----|------|--|
| Bite | 2mm | 3mm | 4mm | | |
| Jaw | Straight Jaw | | | | |

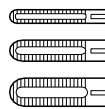

.....Bridging the gap to qualitative healthcare



DISC RONGEUR

Williams Discectomy Rongeur



Single toothed cup 1mm bite
14cm Shaft Length

Williams Discectomy Rongeur Longer Pattern

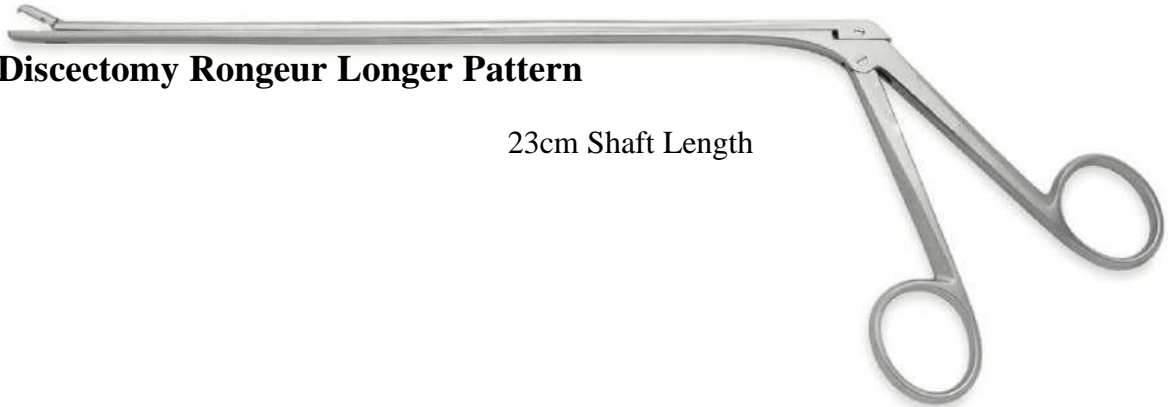

23cm Shaft Length

Pea Pod Disc Rongeur

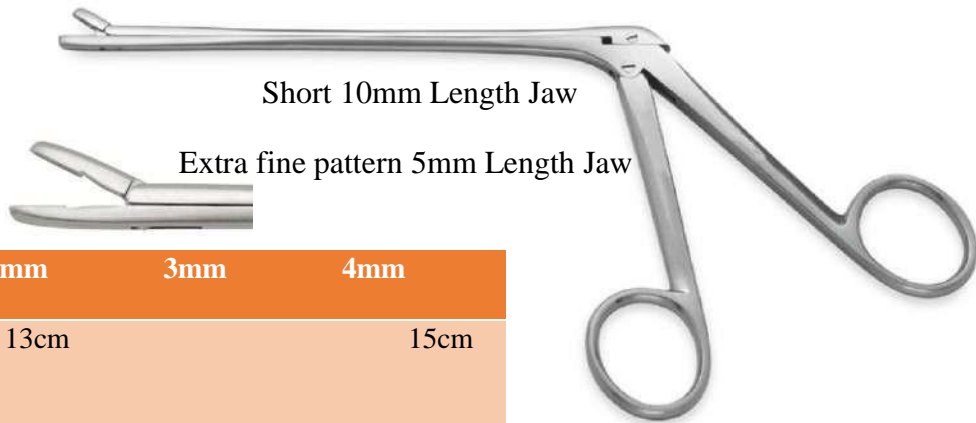

Short 10mm Length Jaw

Extra fine pattern 5mm Length Jaw

| Bite Size | 2mm | 3mm | 4mm |
|--------------|------|-----|------|
| Shaft Length | 13cm | | 15cm |

Beck Disc Rongeur



13cm Shaft Length

2mm Bite Size



Website: www.lithosmed.com

Email: Lithosmed@gmail.com

Telephone: +2347053666407

DISC RONGEUR

Munich Grasping Forceps

18cm/7" Shaft Length
1x2 Teeth



Toothed Serrated Jaw

Weil-Blakesley Forceps

18cm/7" Shaft Length
Fenestrated Jaw



| | | | |
|-----------|--------------|-----------------------|-------|
| Bite Size | 2.5mm | 3mm | 3.5mm |
| Jaw | Straight Jaw | Upward 30° Angled Jaw | |

Decker Rongeur

- 15cm/6" Shaft Length
- Straight Jaw



2mm Jaw

Nicola Micro Cupped Biopsy Forceps

16.5cm/6 1/2" Shaft Length

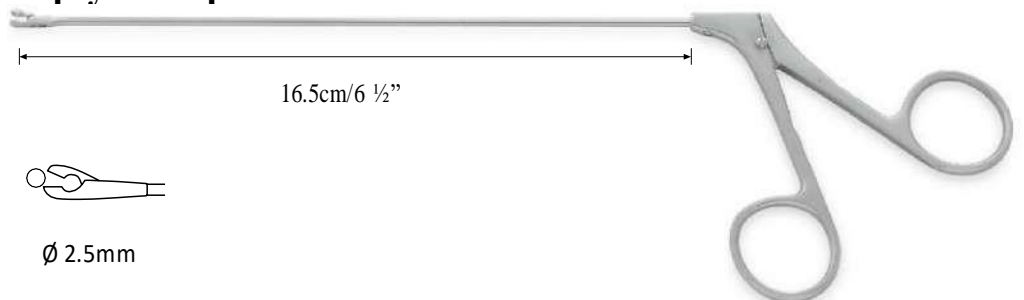

16.5cm/6 1/2"

Ø 2.5mm





Website: www.lithosmed.com

Email: Lithosmed@gmail.com

Telephone: +2347053666407

DISC RONGEUR

Micro Disc Rongeur

17cm/6 3/4" Shaft Length
2mm Bite Size

Black Titanium Coating



Straight Jaw

40° Upward Jaw

Micro Toothed Disc Rongeur

17cm/6 3/4" Shaft Length
2mm Micro Toothed Jaw
Black Titanium Coating
Very Slim Shaft



40° Upward Jaw

Cushing Disc Rongeur

17cm/6 3/4" shaft length
2mm x 10mm short jaw
Black titanium coating



40° Upward Jaw

Toothed Fine Disc Rongeur

17cm Shaft Length
2mm x 10mm Short Jaw
Black Titanium Coating



Straight Jaw





Website: www.lithosmed.com

Email: Lithosmed@gmail.com

Telephone: +2347053666407

DISC RONGEUR

Ferris Smith Disc Rongeur (Ring Handle)

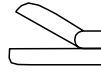
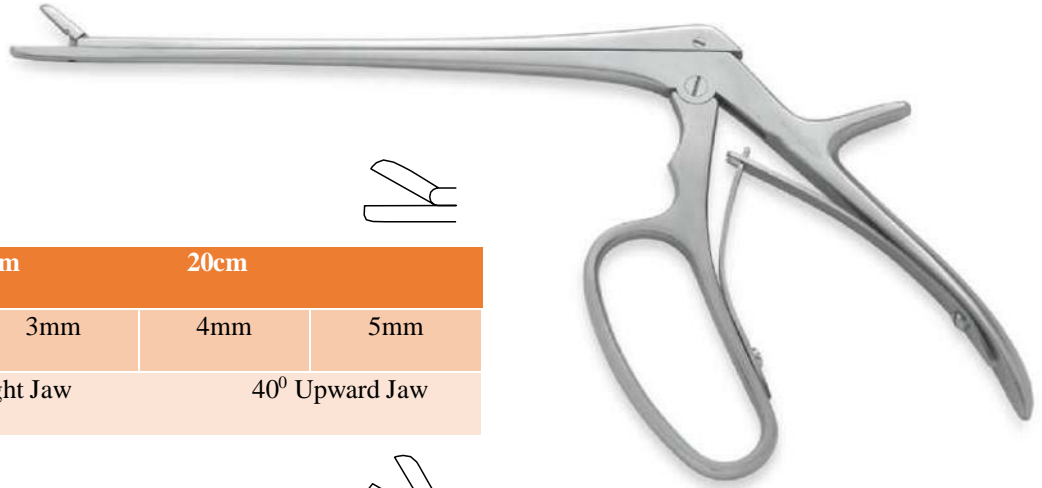

| Shaft | 18cm | | 20cm | |
|-------|--------------|-----|----------------|-----|
| Bite | 2mm | 3mm | 4mm | 5mm |
| Jaw | Straight Jaw | | 40° Upward Jaw | |

Anterior Disc Rongeur

28cm/11" Shaft Length

28cm Longer Shaft for greater reach in anterior approach

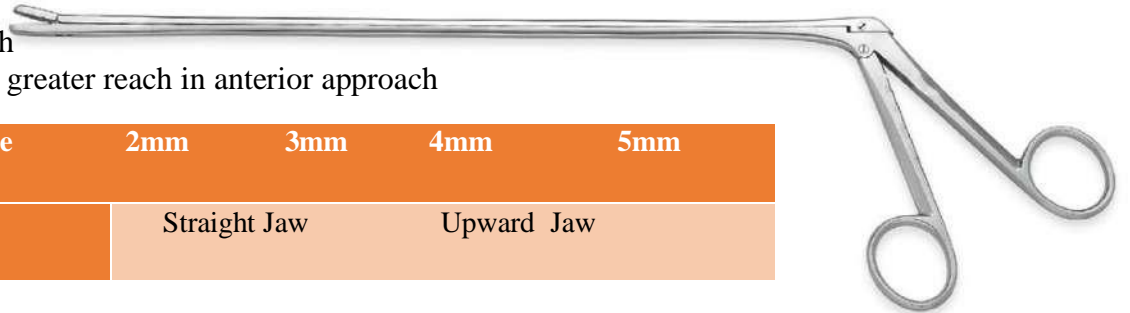

| Bite Size | 2mm | 3mm | 4mm | 5mm |
|-----------|--------------|-----|------------|-----|
| Jaw | Straight Jaw | | Upward Jaw | |

Anterior Disc Rongeur

35cm Shaft Length

Extra Long Length Shaft for deeper area

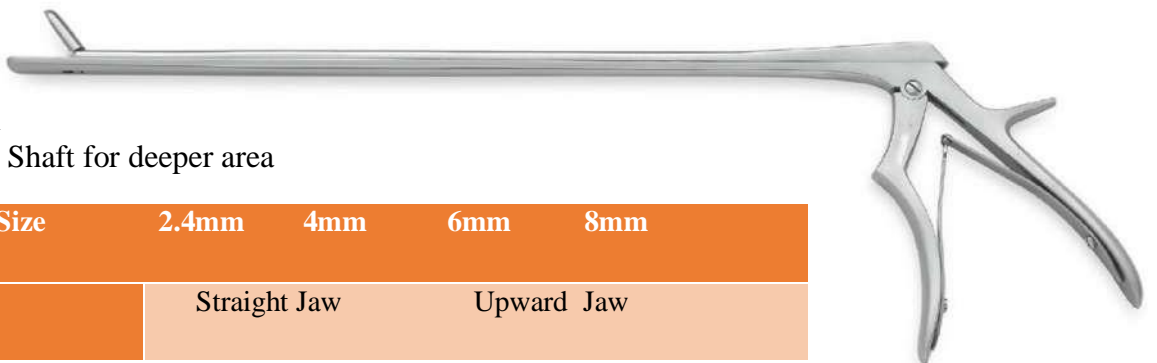

| Bite Size | 2.4mm | 4mm | 6mm | 8mm |
|-----------|--------------|-----|------------|-----|
| Jaw | Straight Jaw | | Upward Jaw | |





Website: www.lithosmed.com

Email: Lithosmed@gmail.com

Telephone: +2347053666407

BONE NIBBLER

Lempert Bone Nibbler

19cm/7^{1/2} Length
Single Action

3mm Bite



Luer Bone Rongeur

18cm/7'' Length
Single Action

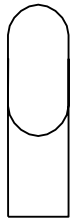

Straight
8mm



Curved
8mm



Adson Bone Nibbler

20cm/8'' Length
Single Action

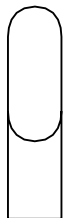

7mm Bite





Website: www.lithosmed.com

Email: Lithosmed@gmail.com

Telephone: +2347053666407

BONE NIBBLER

PennyBacker Bone Nibbler

20cm/8'' Length
Single Action

4mm Bite



Northfield Bone Nibbler

20cm/8'' Length
Single Action

10mm

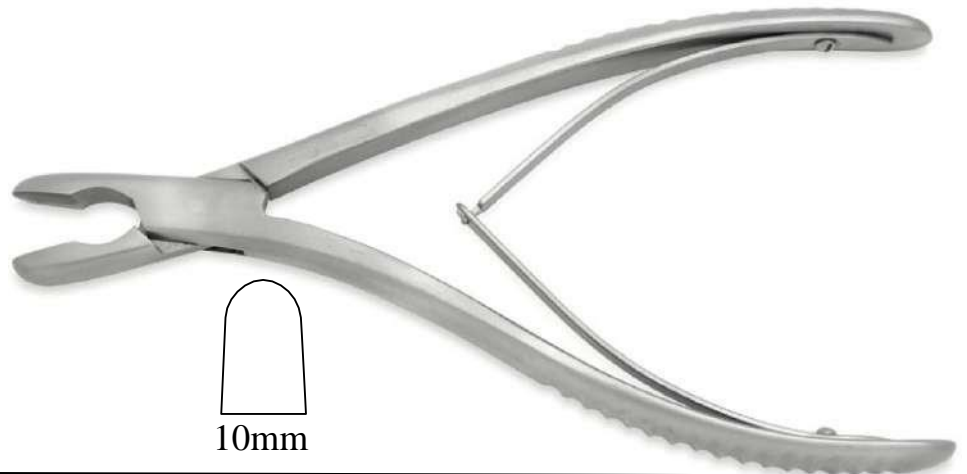

Rat Toothed Bone Nibbler

5mm

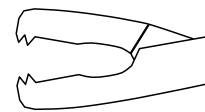

3x3 Teeth

20.5 cm / 8''

With teeth
8 x 15 mm bite
Straight

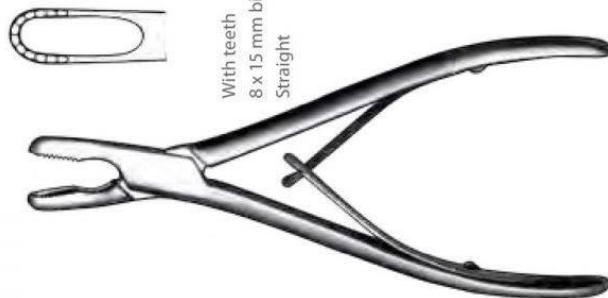

8mm

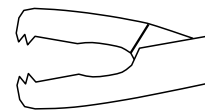

3x3 Teeth





Website: www.lithosmed.com

Email: Lithosmed@gmail.com

Telephone: +2347053666407

BONE NIBBLER

Zielke Intervertebral Rongeur

Angled Parallel Jaw

21cm/8 1/4"

25cm/9 3/4"

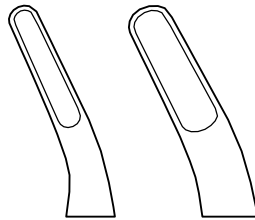

3mm Bite 5mm Bite

Matzen Intervertebral Rongeur

20cm/8'' Length

Angled Jaw

8mm Bite

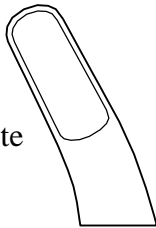

Beyer Bone Nibbler

18cm/7'' Length

Curved Double Action

4mm Bite

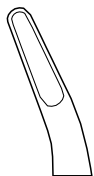



Website: www.lithosmed.com

Email: Lithosmed@gmail.com

Tel: +2347053666407

BONE NIBBLER

Jansen Bone Nibbler

18cm/7'' Length
Curved Double Action

5mm Bite



Marquardt Bone Nibbler

20cm/8'' Length
Curved Double Action

3mm Bite

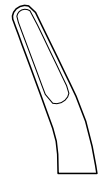

Smith-Peterson Bone Nibbler

24cm/9^{1/2}'' Length
Double Action

| Bite Size | 3mm | 4mm | 5mm | 6mm |
|-----------|--------------|-----|------------------|-----|
| Jaw | Straight Jaw | | Slight Curve Jaw | |

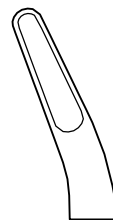

Straight

Slight Curve



Leksell Bone Nibbler

24cm/9^{1/2}'' Length

| Bite Size | 3mm | 5mm | 8mm |
|-----------|------------|-----|-----|
| Jaw | Angled Jaw | | |

I



3mm

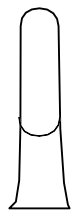

5mm

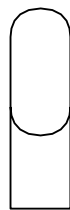

8mm





Website: www.lithosmed.com

Email: Lithosmed@gmail.com

Telephone: +2347053666407

BONE NIBBLERS

Stille Luer Bone Nibbler

22cm/8^{1/2}'' Length
Double Action

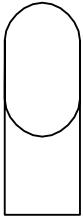

Straight
10mm Bite



Curved
10mm Bite



Mr Blobby Stille Luer Bone Nibbler

26cm/10^{1/4}'' Length / Double Action

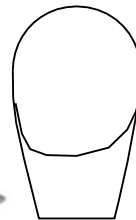

Straight 17mm Bite



Curved 17mm Bite

Echlin Duckbill Nibbler

Echlin Duckbill Nibbler

- 23cm/9" length
- Double action



2mm Bite



3mm Bite



4mm Bite



.....Bridging the gap to qualitative healthcare



Website: www.lithosmed.com

Email: Lithosmed@gmail.com

Telephone: +2347053666407

BONE NIBBLERS

Long Anterior Leksell Bone Nibbler

30cm/12'' Length

Double Action

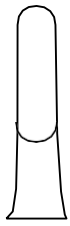

5mm

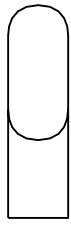

8mm

Sypert Bone Nibbler

36cm/14¹/₄'' Length

Double Action

Very Long

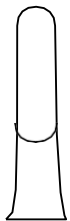

5mm Bite

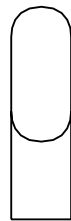

8mm Bite





Website: www.lithosmed.com

Email: Lithosmed@gmail.com

Telephone: +2347053666407

BONE CUTTER

McIndoe Bone Cutter

18cm/7'' Length
Double Action
Angled Jaw



Stille-Liston Bone Cutter

23cm/10^{3/4}'' Length



Straight



Angled



Liston-Key-Horsley Bone Cutters

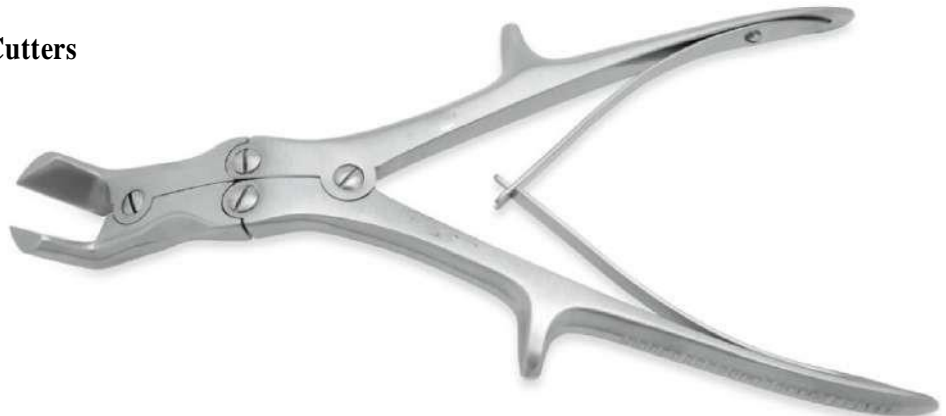

Tudor Edward Vehmehren Costotome (For Cutting Ribs)

24cm/9 1/2'' Length





Website: www.lithosmed.com

Email: Lithosmed@gmail.com

Telephone: +2347053666407

OSTEOTOMES

Capener Osteotome

25cm/9 ¾” Length
Tufnol Handle



| | | | | | | |
|--------------|-------------|-------------|-------------|-------------|-------------|-------------|
| Width | 10mm | 12mm | 15mm | 20mm | 25mm | 30mm |
|--------------|-------------|-------------|-------------|-------------|-------------|-------------|

Lexer Osteotome

22cm/8½” Length
Tufnol Handle



| | | | | | |
|--------------|------------|-------------|-------------|-------------|-------------|
| Width | 7mm | 10mm | 15mm | 20mm | 25mm |
|--------------|------------|-------------|-------------|-------------|-------------|

Dahmen Osteotome

30cm/12” Length
Tufnol Handle



| | | | | | | |
|--------------|------------|-------------|-------------|-------------|-------------|-------------|
| Width | 5mm | 10mm | 15mm | 20mm | 25mm | 30mm |
| Jaw | Straight | | Angled | | | |

Scaglietti Straight Osteotome Set

28cm/11” Length



| | | | | | |
|--------------|------------|------------|-------------|-------------|-------------|
| Width | 6mm | 9mm | 12mm | 16mm | 19mm |
|--------------|------------|------------|-------------|-------------|-------------|





Website: www.lithosmed.com

Email: Lithosmed@gmail.com

Telephone: +2347053666407

OSTEOTOMES

Lambotte Osteotome

25cm/9 1/2'' Length

23cm/9'' Length



| Width | 4mm | 6mm | 8mm | 10mm | 12mm | 14mm | 16mm | 18mm | 20mm | 25mm | 30mm |
|-------|----------|-----|-----|------|------|------|--------|------|------|------|------|
| Jaw | Straight | | | | | | Curved | | | | |

Mini Stille Osteotome

16cm Length



| Width | 4mm | 6mm | 8mm |
|-------|----------|-----|-----|
| Jaw | Straight | | |

Stille (Swedish) Osteome

20cm/8'' Length



| Width | 6mm | 8mm | 10mm | 12mm | 15mm | 20mm | 25mm | 30mm |
|-------|----------|-----|------|------|------|------|------|------|
| Jaw | Straight | | | | | | | |

Hibbs Osteotome with Thin Blade

20cm/8'' Length

Extra Thin Blade



| Width | 4mm | 6mm | 8mm | 10mm | 12mm | 15mm | 20mm | 25mm | 30mm |
|-------|----------|-----|-----|------|------|--------|------|------|------|
| Jaw | Straight | | | | | Curved | | | |

Smith Peterson Osteotome

20cm/8'' Length

| Width | 10mm | 15mm | 20mm | 25mm | 30mm |
|-------|------|------|------|------|------|
|-------|------|------|------|------|------|





Website: www.lithosmed.com

Email: Lithosmed@gmail.com

Telephone: +2347053666407

MALLETS

Toffee Mallet

19cm/7^{1/2}'' Length
22mm Head Size
Weight 165g/6oz



Ultra Fine Mallet

17cm/6^{3/4}'' Length
20mm Head Size
Weight 145g/5oz



Heath Mallet

19cm/7'' Length
Stainless Steel Head
40mm Head Size
Weight 102oz/36oz



Mallet With Tufnol Handle



| Head | Small | Medium | Large |
|--------|-----------|-----------|-----------|
| Size | 30mm Ø | 35mm Ø | 40mm Ø |
| Weight | 350g/12oz | 550g/20oz | 700g/25oz |





Website: www.lithosmed.com

Email: Lithosmed@gmail.com

Telephone: +2347053666407

MALLETS

London Splint Mallet

18cm/7'' Length
30mm Ø Head Size
Weight 450g/16.2oz



Ombredanne Mallet

24cm/9 1/2'' Length
40mm Ø Head Size
Weight 550g/20oz



Mallet with Tufnol Handle

24cm/9 1/2'' Length
Lead Filled Head
Weight 400g/14oz



Tufnol Mallet

25.5cm/10'' Length
42mm Ø Head Size
250g/10oz





Website: www.lithosmed.com

Email: Lithosmed@gmail.com

Telephone: +2347053666407

COBBS ELEVATORS

Cobbs Spinal Elevator

31cm/12^{1/4}'' Overall Length
18cm/7'' Handle Length

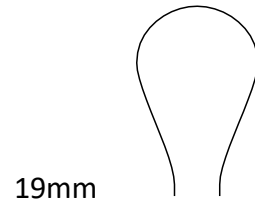
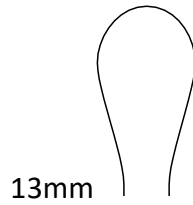
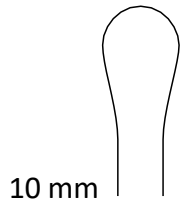

Harrington Cobb Spinal Elevator

30.5cm/12'' overall Length

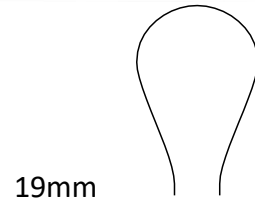
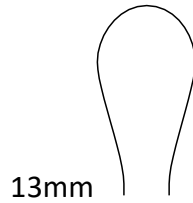
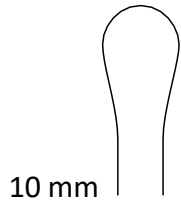

Cobbs Spinal Elevator Extra Long Handle

34cm/13^{1/2}'' Overall Length
22cm/8^{3/4}'' Handle Length

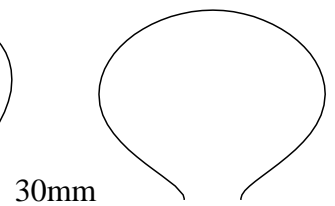
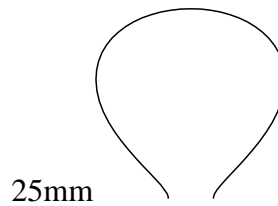
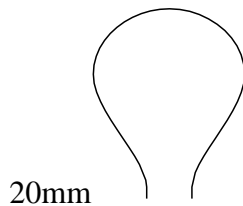
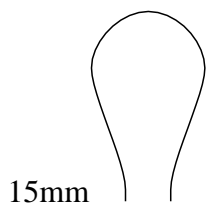
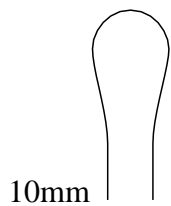



Website: www.lithosmed.com

Email: Lithosmed@gmail.com

Telephone: +2347053666407

COBBS ELEVATORS

Comfort Cobbs Elevator

32cm/12^{1/2}'' Overall Length

20cm/8'' Handle Length

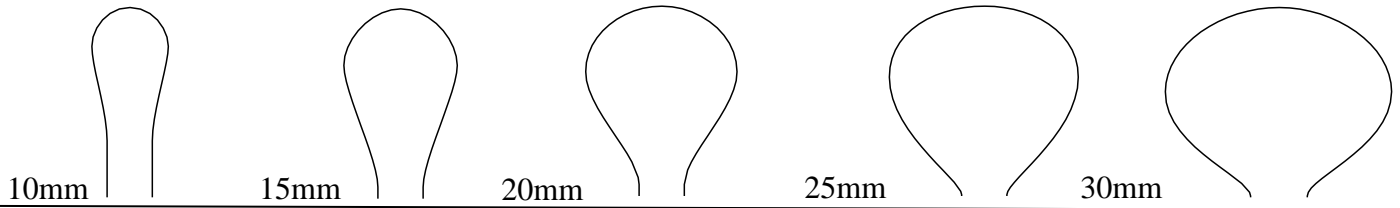

Karl Cobbs Elevator

32.5cm/12^{1/4}'' Overall Length

20cm/8'' Handle Length

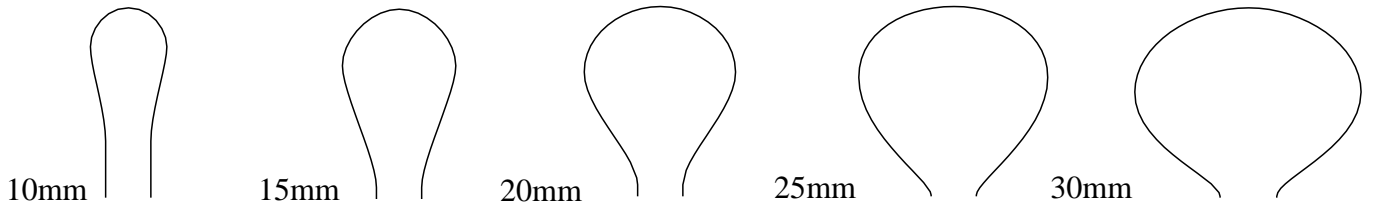

Long Anterior Comfort Cobbs Elevator

47cm/18^{1/4}'' Overall Length

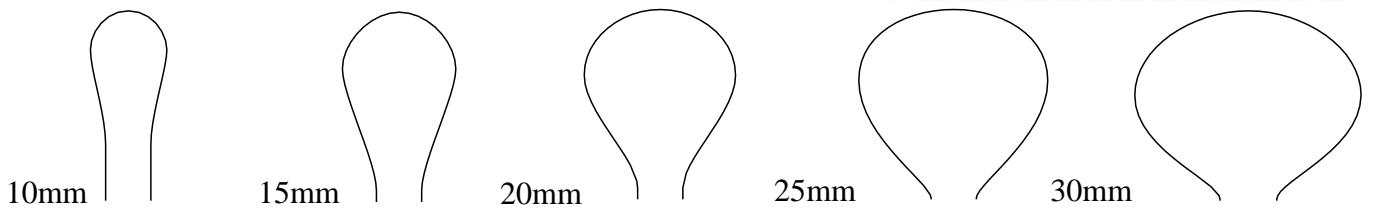



Website: www.lithosmed.com

Email: Lithosmed@gmail.com

Telephone: +2347053666407

ELEVATORS

Adson Periosteal Elevator

16cm/6^{1/4}" length
Curved Blunt



| | | |
|--------------|-----|-----|
| Width | 5mm | 7mm |
|--------------|-----|-----|

Pennybacker Periosteal Elevator

16cm/6^{1/4}" length

Curved Sharp



| | | | |
|--------------|-----|-----|-----|
| Width | 4mm | 6mm | 8mm |
|--------------|-----|-----|-----|

Bone Raspatory with Tufnol Handel

19cm/7^{1/2}" length

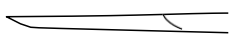

Straight Width



Curved Width

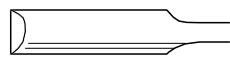

6 m m

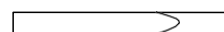

3mm 6mm

Farabeuf Rugine Elevator

15cm/6" length

| Width | |
|-----------------|------|
| Straight | 12mm |
| Curved | 12mm |



.....Bridging the gap to qualitative healthcare



Website: www.lithosmed.com

Email: Lithosmed@gmail.com

Telephone: +2347053666407

ELEVATORS

Farabeuf Ruginé Elevator with Hollow Handle

16cm/6^{1/4}" length



| Width | |
|----------|------|
| Straight | 12mm |
| Curved | 12mm |





Website: www.lithosmed.com

Email: Lithosmed@gmail.com

Telephone: +2347053666407

ELEVATORS & GOUGES

Trethowan Bone Elevator

22.5cm/8¹/₂" length



Bristow Periosteal Elevator

23cm/9" length

Curved sharp

10mm width



Zielke S-Shaped Gouges

23cm/9" length



Curved width

| Width | | |
|-----------------|-----|-----|
| S-Shaped | 6mm | 9mm |
| Curved | 6mm | 9mm |

Capener Lamina Gouges

23cm/9" length

Cranked shaft



| Width | 6mm | 8mm | 11mm | 16mm |
|-------|-----|-----|------|------|
| | | | | |





Website: www.lithosmed.com

Email: Lithosmed@gmail.com

Telephone: +2347053666407

DISSECTORS

Swedish Dissectors

18cm/7" overall length



Howarth Elevator

21.5cm/8¹/₂" overall length



MacDonald Elevators Dissectors



| | | |
|-------------|---------|---------|
| Size | 18cm/7" | 23cm/9" |
|-------------|---------|---------|

Watson Cheyne Dissector



| | | | |
|-------------|---------|---------|------------|
| Size | 18cm/7" | 23cm/9" | 25.5cm/10" |
|-------------|---------|---------|------------|

Freers Elevators/Dissector

18.5cm/7¹/₄" overall length





Website: www.lithosmed.com

Email: Lithosmed@gmail.com

Telephone: +2347053666407

BONE GRAFT IMPACTORS

Cervical Bone Graft Impactor 90° offset

22cm/8¹/₂" length

18cm Length

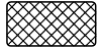

6mm x 12mm Tip

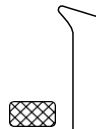

3.5mm x 6mm Tip



Lumbar Bone Graft Impactor

22cm/8¹/₂" length

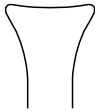
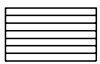

7mm x 12mm

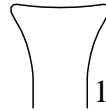
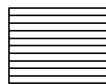

10mm x 13mm



Anterior Bone Graft Impactor

34cm/13¹/₂" length

9 x 16mm Tip

9 x 23mm Tip

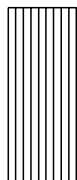
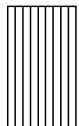

Caspar Bone Graft Holder and Impactor

21.8cm/8¹/₄" length

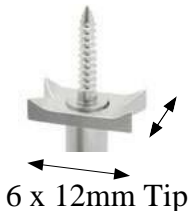

6 x 12mm Tip

Dowel holder for making larger block Grafts and for vertebral body replacement





BAYONET CERVICAL MICRO CURETTES

Cervical Micro Discectomy Curettes Set

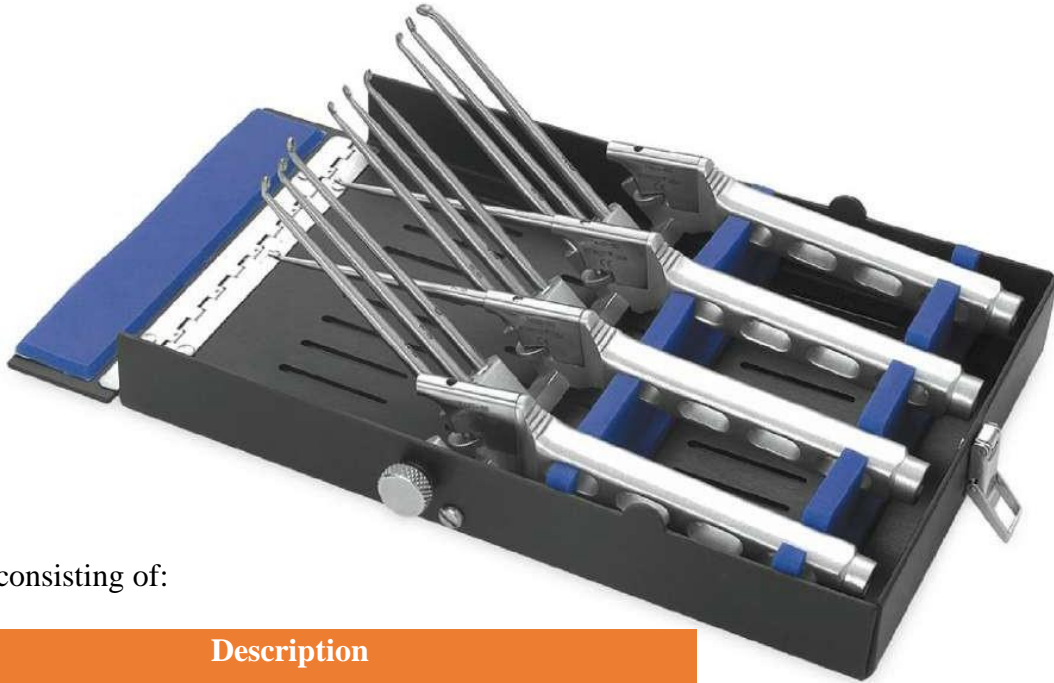

Complete set consisting of:

| Qty | Description |
|-----|---|
| 4 | Curette Handles |
| 12 | Cervical Curette Shafts – Includes |
| | 5 Straight Shafts/ 5 Angled Shafts/ 2 Down Pushing Shafts |
| 1 | Sterilising Case |

Slim Micro Discectomy Curettes Handle



- Bayonet handled design for improved visualisation
- 360° rotating shafts are interchangeable
- Shafts length is adjustable
- Light weight handle
- Instrument length: 23cm max. for standard curettes
- Shafts length 10cm

| | | | | | |
|-----------------|-------|------|-----|----|---|
| | ⊙ | ⊙ | ⊙ | ⊙ | ⊙ |
| Cup Size | 00000 | 0000 | 000 | 00 | 0 |

| | | |
|------------------|----------|-------------|
| Dimension | Straight | Forward Cup |
|------------------|----------|-------------|





Website: www.lithosmed.com

Email: Lithosmed@gmail.com

Telephone: +2347053666407

BAYONET CERVICAL MICRO CURETTES



Bayonet Cervical Curette

24cm/9^{1/2}" overall length

12cm/4^{3/4}" shaft length



Straight

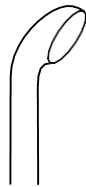

Forward Angled



Backward Straight



Backward Angled

| Dimension | Straight | Forward Angled | Backward Straight | Backward Angled | |
|----------------------------------|----------|----------------|-------------------|-----------------|-----|
| Cup Size | 0.5mm | 1mm | 2mm | 3mm | 4mm |
| Bone Cutters/Knife Handle | | | | | |



Container for 12 Curettes



.....Bridging the gap to qualitative healthcare



Website: www.lithosmed.com

Email: Lithosmed@gmail.com

Telephone: +2347053666407

SPINAL CURETTES

Lempert Curettes

21cm/8¹/₄" overall length^h



| Dimension | Straight | | | Angled | | |
|-----------|----------|------|-----|--------|---|---|
| Cup Size | 00000 | 0000 | 000 | 00 | 0 | 1 |

Bruns Curettes

23cm/9" Overall Length



| Dimension | Straight | | | Angled | | |
|-----------|----------|----|---|--------|---|---|
| Cup Size | 000 | 00 | 0 | 1 | 2 | 3 |

Tufnol Handle Micro Curettes

26cm/10" overall length



| Dimension | Straight | | Angled | |
|-----------|----------|-----|--------|---|
| Cup Size | 0000 | 000 | 00 | 1 |





Website: www.lithosmed.com

Email: Lithosmed@gmail.com

Telephone: +2347053666407

SPINAL CURETTES

Cobb Bone Curettes

28cm/11" length



| | | | | | | | | | | |
|--------------|----------|-----|-----|-----|-----|--------|-----|-----|-----|-----|
| Cup Straight | 2.0 | 2.5 | 3.0 | 3.5 | 4.0 | 4.5 | 5.0 | 5.5 | 6.5 | 8.0 |
| Dimension | Straight | | | | | Angled | | | | |

Comfort Handle Curettes

29cm/11^{1/2}" overall length

20cm/8" handle length



| | | | | | |
|-------------------|-------|-------|------|------|------|
| Straight cup size | 6.5mm | 8.5mm | 11mm | 13mm | 15mm |
| Angled cup size | 6.5mm | 8.5mm | 11mm | 13mm | 15mm |

Long Anterior Curettes

38cm/15" overall length

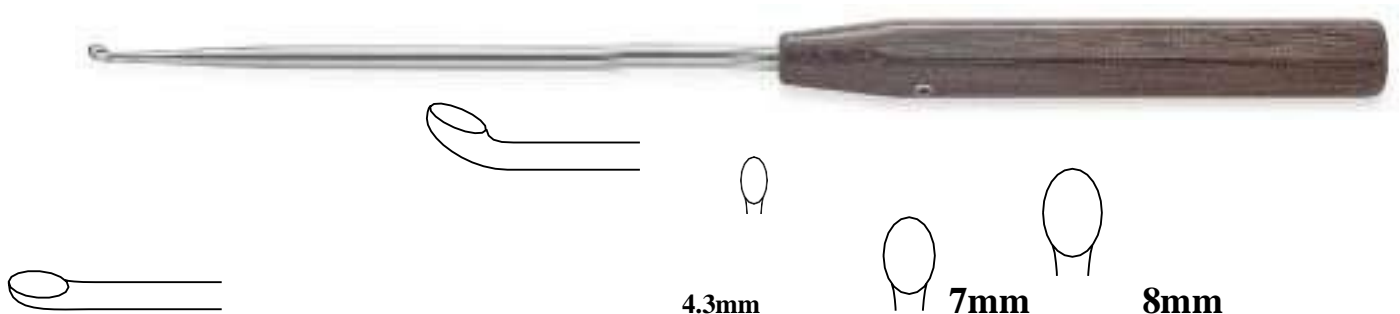

| | | | |
|-----------|----------|-----|--------|
| Dimension | Straight | | Angled |
| Cup Size | 4.3mm | 7mm | 8mm |





Website: www.lithosmed.com

Email: Lithosmed@gmail.com

Telephone: +2347053666407

SPINAL CURETTES

Light-Grip Cervical Curettes

26cm/10¹/₄" overall length

13cm/5¹/₄" handle length

Colour coded handle



Straight



Forward Angled



Down Angled

Light -Grip Cervical Curettes Rack
Holds 12 Cervical Curettes

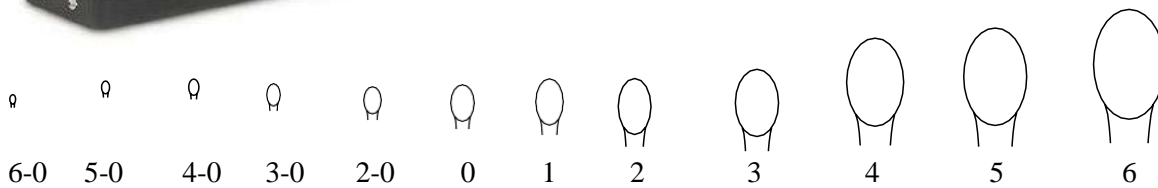

| Cup Size | 6-0 | 5-0 | 4-0 | 3-0 | 2-0 | 0 | 1 | 2 | 3 | 4 | 5 | 6 |
|-----------|----------|-----|-----|----------------|-----|---|---|---|---|-------------|---|---|
| Dimension | Straight | | | Forward Angled | | | | | | Down Angled | | |



.....Bridging the gap to qualitative healthcare



Website: www.lithosmed.com

Email: Lithosmed@gmail.com

Telephone: +2347053666407

SPINAL CURETTES

Light-Grip Lumbar Currettes

34cm/13^{1/2}" overall length

20cm/8" handle length

Colour coded handles



Straight



Forward Angled



Down Angled

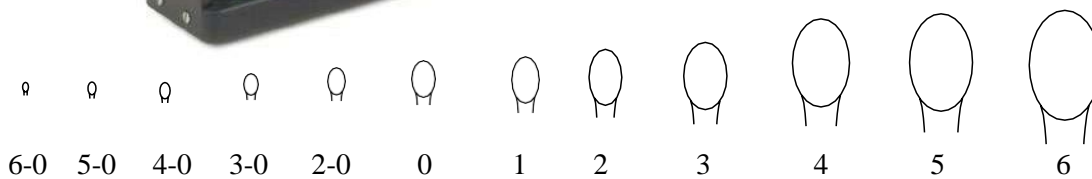

| Cup Size | 6-0 | 5-0 | 4-0 | 3-0 | 2-0 | 0 | 1 | 2 | 3 | 4 | 5 | 6 |
|-----------|----------|-----|-----|----------------|-----|---|---|---|---|-------------|---|---|
| Dimension | Straight | | | Forward Angled | | | | | | Down Angled | | |



.....Bridging the gap to qualitative healthcare



Website: www.lithosmed.com

Email: Lithosmed@gmail.com

Telephone: +2347053666407

SPINAL CURETTES

Cones Ring Curettes

23cm/9" overall length



○ 3mm

○ 6mm

| | | | |
|-----------|----------|--------|-----|
| Ring size | 3mm | 6mm | 8mm |
| Dimension | Straight | Angled | |

Karl Ring Curettes

32.5cm/12^{3/4}" overall length



○ 6mm ring size

○ 10mm ring size

| | | | |
|-----------|----------|--------|------|
| Ring size | 6mm | 8mm | 10mm |
| Dimension | Straight | Angled | |





Website: www.lithosmed.com

Email: Lithosmed@gmail.com

Telephone: +2347053666407

SPINAL CURETTES

Zielke Currettes

21cm/8^{1/4}" overall length



| | | |
|------------------|----------|--------|
| Size | 8mm | 11mm |
| Dimension | Straight | Angled |

Volkman Double Ended Currettes

22cm/8^{3/4}" overall length

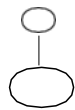

Small

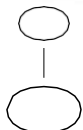

Medium

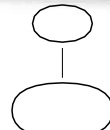

Large

| | | | |
|-------------|-------|--------|-------|
| Size | | | |
| | Small | Medium | Large |





CASPAR CERVICAL DISTRACTION SET



Caspar Vertebral Body Distraction Set

- For retraction of the vertebral body in the
- Cervical spine to allow access to the disc.
- Less instrumentation in the disc space.
- Distraction screws are secured into the
- Vertebral body either side of the disc, the
- Retractor is then slid over the screws and retracted.

| Qty | Description |
|-----|---|
| 1 | Retractor Right |
| 1 | Drill Guide Right |
| 1 | Screw Driver |
| 1 | Distraction Drill |
| 1 | Sterile Distraction Screw 14mm Boxes of 10 |

Distraction Retractors

Right



Left





CASPAR CERVICAL DISTRACTION SET

Drill Guide

Right

Left



Screw Driver



Distraction Drill

- For pre- drilling pilot holds for distraction screws in combination with the drill guide
- Drill 2mm



Caspar Distraction Screw

- 7cm/2³/₄" post length
- Sterile packed

| Thread length | 12mm | 14mm | 16mm |
|---------------|------|------|------|
| | | | |

Thread Length



Supplied sterile in box of 10





Website: www.lithosmed.com

Email: Lithosmed@gmail.com

Telephone: +2347053666407

LAMINA & VERTEBRAL SPREADERS

Cervical Vertebral Spreader

13cm/5^{1/4}" length
3mm Tip

Illustrated Depth 95mm

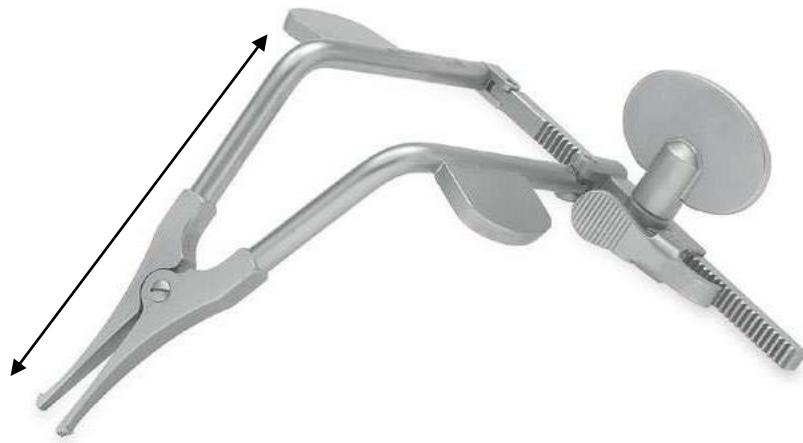

| Depth | |
|-------|------|
| 70mm | 90mm |

Cloward Cervical Spreader

17cm/6^{3/4}" length
Max opening 20mm



Depth
50mm





Website: www.lithosmed.com

Email: Lithosmed@gmail.com

Telephone: +2347053666407

LAMINA AND VERTEBRAL SPREADERS

Cloward Lamina Spreader

15cm/6" length



Baby Inge Lamina Spreader

18cm/7" length

7mm smooth



7mm cross serrated

7mm toothed



Scaglietti Lamina Spreader

28cm/11" length

With spread lock





Website: www.lithosmed.com

Email: Lithosmed@gmail.com

Telephone: +2347053666407

Inge Lamina Spreader

24cm/9^{1/2}” length
Max opening 50mm

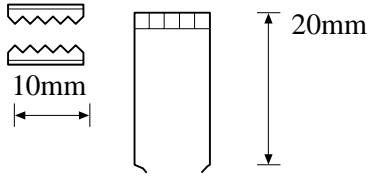

Long Anterior Lamina Spreader

28cm/11” length
Max opening 40mm





Website: www.lithosmed.com

Email: Lithosmed@gmail.com

Telephone: +2347053666407

HOOKS & PROBES

Pedicle Probe

22.5cm/8^{3/4}" length
Graduated with ball Tip



Pedicle Probe

27.5cm/11^{1/2}" length
Graduated with ball Tip



Adson Dural Hook

19cm/7^{1/2}" length
3mm Tip length



Sharp Blunt

Weary Blunt Nerve Hook

19.5cm/7^{3/4}" length
6mm fine Tip length



Crile Blunt Hook

20cm/8" length
7mm tip length





Website: www.lithosmed.com

Email: Lithosmed@gmail.com

Telephone: +2347053666407

HOOKS AND PROBES

Emmet Sharp Hook

22cm/8³/₄" length
5mm tip length



Cushing Blunt Hook

28cm/11" length
5mm tip length



Adson Hook

20cm/8" length
5mm tip length



Sharp



Blunt



Ball Tipped Probe

23cm/9" length
2mm ball



4mm



6mm



8mm





PROBES AND HOOKS

Ball Tipped Probe- Fine Pattern

23cm/9" length

1mm ball



4mm



6mm



8mm



Manipulation Hook

23.5cm/9¹/₄" length

4mm tip length



Blalock Blunt Hook

24cm/9¹/₂" length

5mm tip length



Caspar Exploration Hook Insulated

24.5cm/9³/₄" length

Insulated Shaft

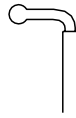



RHOTON MICRO DISSECTOR

Titanium Micro Round Dissectors

19cm/7^{1/2}" length



1mm small



No. 1

2mm medium



No. 2

3mm large



No. 3

Titanium Micro Elevator

19cm/7^{1/2}" length



Curved



No. 4

Angled



No. 5

Titanium Micro Spatula Dissectors

19cm/7^{1/2}" length



1mm small

No. 7



1.7mm medium

No. 8



2mm large

No. 9

Titanium Micro Hook

19cm/7^{1/2}" length



90° semi-sharp



No. 9

90° blunt



No. 10

45° semi-sharp



No. 11

straight point needle



No. 12





Website: www.lithosmed.com

Email: Lithosmed@gmail.com

Telephone: +2347053666407

RHOTON MICRO DISSECTORS

Titanium Micro Curettes

19cm/7^{1/2}" length



Small cup

Large cup



No.13

No. 14

Titanium Micro Ball Dissectors

19cm/7^{1/2}" length



No. 15

No. 16

No. 17

No. 18

No. 19



Straight

90°3mm Tip

90°5mm Tip

40°4mm Tip

40°8mm Tip

COMPLETE SET

- Includes Rack and 19 Micro Dissector

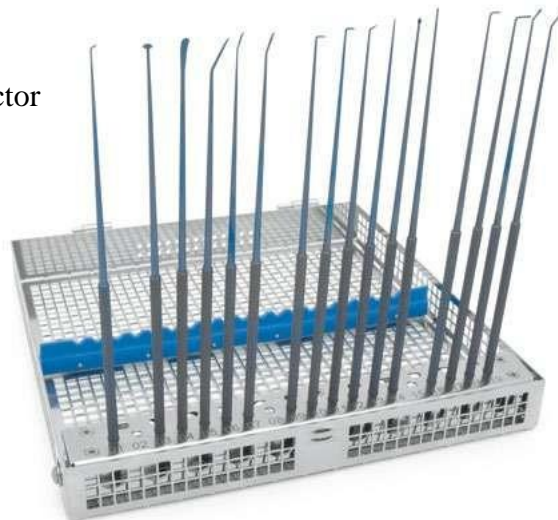

.....Bridging the gap to qualitative healthcare



Website: www.lithosmed.com

Email: Lithosmed@gmail.com

Telephone: +2347053666407

RHOTON MICRO DISSECTORS

Dissector Sterilising Rask

To hold 19 Micro Dissector





Website: www.lithosmed.com

Email: Lithosmed@gmail.com

Telephone: +2347053666407

NERVE ROOT RETRACTORS

Love Bayonet Nerve Root Retractor

21cm 8¹/₄" length

Width:4mm



Krayenbuhl Nerve Root Retractor

Double Bayonet

Width

21cm/8¹/₄"

24cm/9¹/₂"

3mm

4mm



Caspar Bayonet Nerve Root Retractor

24cm/9¹/₂" length



Width

4mm

6mm

O'Connell Nerve Root Retractor

21.5cm/8¹/₂" length



Love Nerve Root Retractor

22cm/8³/₄" length

5mm Tip width

Straight

25° Angled

90° Angled



LithosMed

.....Bridging the gap to qualitative healthcare



Website: www.lithosmed.com

Email: Lithosmed@gmail.com

Telephone: +2347053666407

NERVE ROOT RETRACTORS

McCulloch Nerve Root Retractor

12.5cm/5" working length

90° angled

6mm Tip



Shepherd Suction Nerve Root Retractor

- With suction aspiration
- Fibre optic Illumination
- 4mm Tip width

26cm/10^{1/2}" length

31cm/12^{1/4}" length

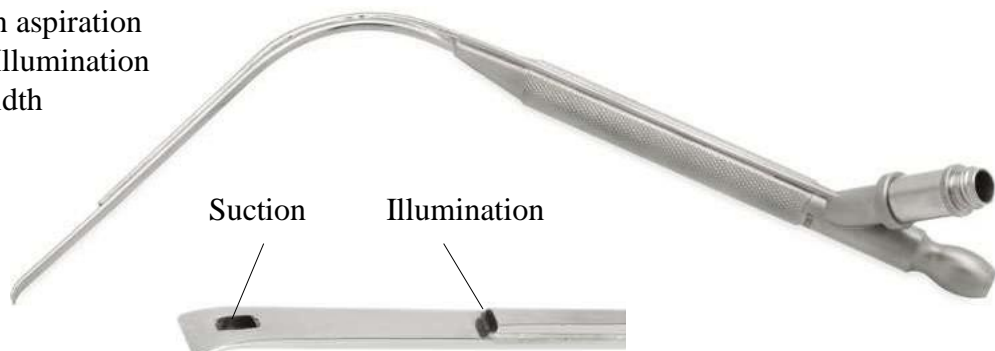



Website: www.lithosmed.com

Email: Lithosmed@gmail.com

Telephone: +2347053666407

NERVE ROOT RETRACTORS

Nerve Root Retractor

- 31cm/12" length
- With suction
- 7mm Tip width



Hess Nerve Root Retractor

19cm/7^{1/2}" length

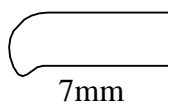
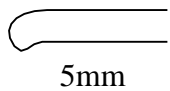
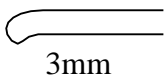

| Width | | | |
|-------|-----|-----|-----|
| 3mm | 4mm | 5mm | 7mm |

Nerve Root Retractor

19cm/7^{1/2}" length

With fibre optic Illumination



| Width | |
|-------|-----|
| 3mm | 5mm |





Website: www.lithosmed.com

Email: Lithosmed@gmail.com

Telephone: +2347053666407

HAND HELD RETRACTORS

Meyerding Retractor

22.5cm/9" length

| Blade Size |
|-------------|
| 50mm x 16mm |
| 75mm x 25mm |
| 90mm x 50mm |



Taylor Hip Retractor

19cm/7^{1/2}" Length



| Depth |
|-------|
| 70mm |
| 85mm |
| 100mm |





Website: www.lithosmed.com

Email: Lithosmed@gmail.com

Telephone: +2347053666407

HAND HELD RETRACTORS

Cloward Style Blade Retractor

11cm/4 1/4" Length



| Blade Size |
|------------|
| 13mm |
| 18mm |
| 20mm |

Langenbeck Retractor

22.5cm/9" length

21.5cm/8 1/2" length



| Blade Size | |
|-------------|-------------|
| 22mm x 6mm | Small |
| 45mm x 13mm | Medium |
| 65mm x 25mm | Large |
| 90mm x 20mm | Extra Large |



LithosMed

.....Bridging the gap to qualitative healthcare



Website: www.lithosmed.com

Email: Lithosmed@gmail.com

Telephone: +2347053666407

HAND HELD RETRACTORS

Volkman Catspaw Retractor

21.5cm/8^{1/2}" length

Semi-sharp teeth

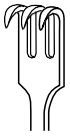

15 x 15mm
3 prong

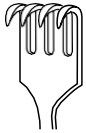

15 x 20mm
4 prong

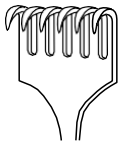

15 x 30mm
6 prong





Website: www.lithosmed.com

Email: Lithosmed@gmail.com

Telephone: +2347053666407

SELF RETAINING RETRACTORS

Wests S/R Retractors

14cm/5^{1/2}" length
3 x 4 sharp prongs
Prongs depth 18mm



Weitlaner S/R Retractors

14cm/5^{1/2}" length
3 x 4 Blunt prongs
Prongs depth 18mm

Mollison S/R Retractor - Child

13cm/5^{1/4}" length
2 x 2 sharp prongs 12mm depth



Mollison S/R Retractor- Adult

17cm/6^{3/4}" length
4 x 4 sharp prongs 15mm depth





SELF RETAINING RETRACTORS

Jefferson S/R Retractor

13cm/5¹/₄" length

3 x 4 Blunt prongs 16mm depth



Irwin S/R Retractor

17.5cm/6³/₄" length

4 x 4 Sharp Prongs

Prong depth 20mm



Travers S/R Retractor

20cm/8" length

4 x 5 Blunt Prongs

Prong depth 26mm





SELF RETAINING RETRACTORS

Norfolk and Norwich S/R Retractor

20cm/8" length
4 x 5 Blunt prongs
Prong depth 50mm x 23cm width



Norfolk and Norwich Deeper Prong S/R Retractor

20cm/8" length
4 x 5 Blunt prongs
Prongs depth 70mm x 23mm Width



Cones Self Retaining Retractor

3 x 4 Prongs
Jointed arms

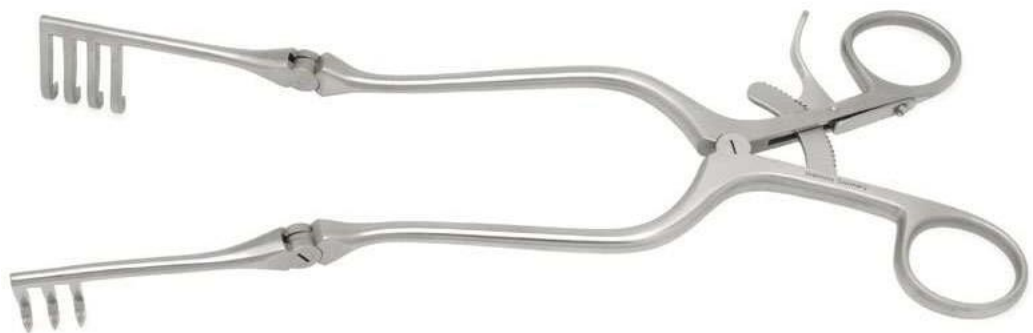

| Dimension | Blunt Prong | | Sharp Prong | |
|-----------|-------------|-------------------------|-------------|-------------------------|
| Length | 13cm/5" | 16cm/6 ^{1/2} " | 20cm/8" | 24cm/9 ^{1/2} " |
| Depth | 15mm | 15mm | 20mm | 25mm |





SELF RETAINING RETRACTORS

Harvey Jackson Self Retaining Retractor

30.5cm/12" length
Prongs depth 45mm
3 x 3 Sharp Prongs



Beckman Adson Retractor

- 33cm/13" length
- 4 x 5 Blunt prongs
- Prongs depth 32mm
- Jointed arms



Gelpi Laminectomy Retractor



| Dimension | Blunt Prong | | Sharp Prong | |
|-------------|--|--|-------------|---------|
| Length | 18.5cm/7 ¹ / ₄ " | 19.5cm/7 ¹ / ₄ " | 20cm/8" | 20cm/8" |
| Prong Depth | 30mm | 50mm | 70mm | 90mm |





SELF RETAINING RETRACTORS

Hardman Retractor

20cm/8" length

Prongs depth

50mm equal prong

Long prong- Left

Long prong-Right

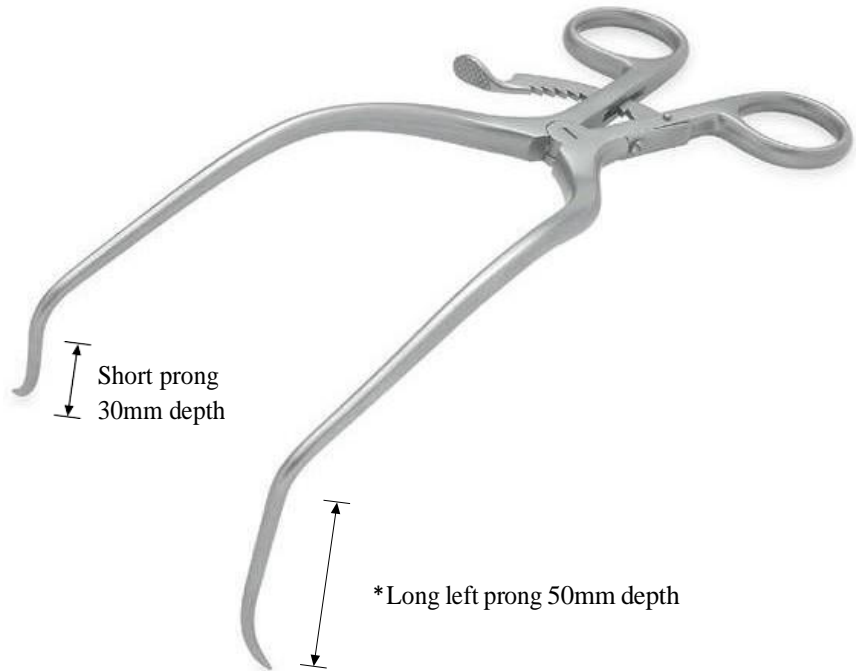

Meyerding Hemi Laminectomy Retractor

18cm/7" length



| Blade Size | Solid Blade Right | Solid Blade Left |
|---------------------|-------------------|------------------|
| Narrow Blade | | |
| | 50 x 10mm | |
| | 60 x 10mm | |
| | 70 x 10mm | |
| Wide Blade | | |
| | 50 x 20mm | |
| | 60 x 20mm | |
| | 70 x 20mm | |





Website: www.lithosmed.com Email: Lithosmed@gmail.com Phone: +2347053666407

SELF RETAINING RETRACTORS

Viper Hinged Scoliosis Retractor

- 30cm/11^{3/4}" Length
- Sharp
- Hinged/Non Hinged

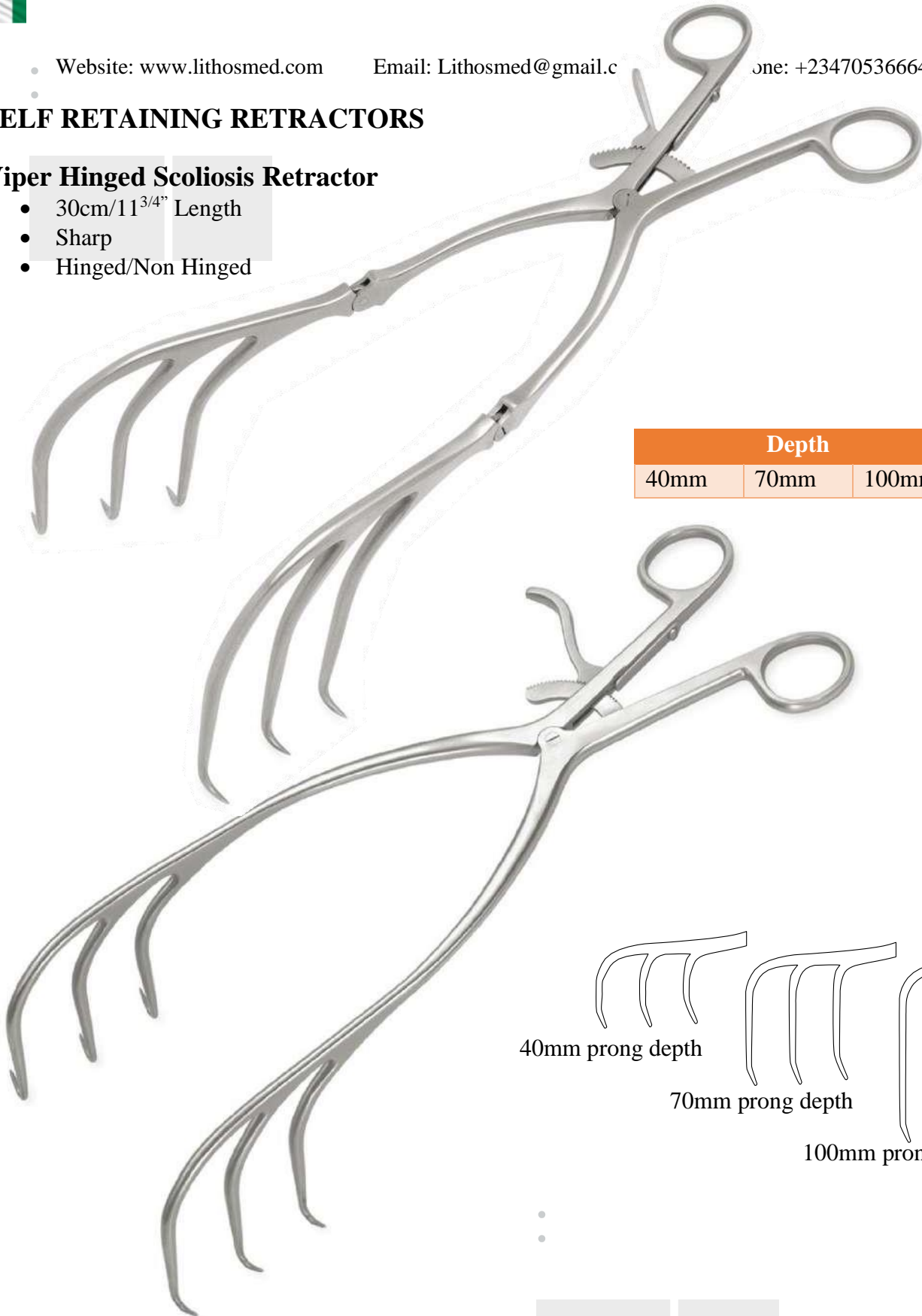

| Depth | | |
|-------|------|-------|
| 40mm | 70mm | 100mm |

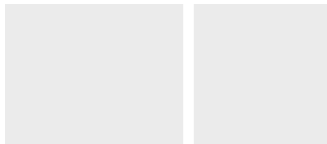
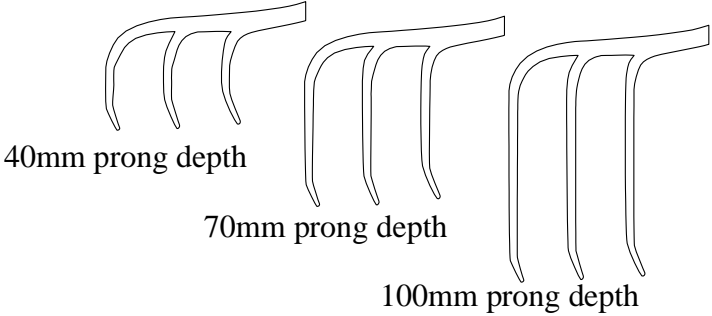



McCULLOCH RETRACTORS SET



This specialist Retractor allows the consultant the optimal exposure to the disc with minimum Incision
The design of the retractor allows unhindered access around the wound with the jointed arms folding along the patients back.

The black finishing eliminates distracting reflections under the microscope during surgery
The wide selections of blade available allows the surgeon full flexibility in approaches to the disc

Basic McCulloch Retractor Set

Complete Set consisting of

| Qty | Description |
|--------|--|
| 1each | Retractor frame |
| 4pairs | Wide muscle blade Sizes 4cm to 7cm depth |
| 4pairs | Narrow muscle blade Size 4cm to 7cm depth |
| 4each | Hook blade Size 3cm to 6cm depth |
| 4each | Toothed blade Size 3cm to 6cm depth |
| 1each | Instrument container |

Extended McCulloch Retractor Set

Complete Set Consisting of

| Qty | Description |
|--------|---|
| 2each | Retractor frame |
| 6pairs | Wide muscle blade Sizes 3cm to 8cm depth |
| 6pairs | Narrow muscle blade Sizes 3cm to 8cm depth |
| 6each | Hook blade Sizes 2cm to 7cm depth |
| 6each | Toothed blade Sizes 2cm to 7cm depth |
| 1each | Instrument container |





McCULLOCH RETRACTORS SET

Jointed Arms



Wide muscle blade – 6 teeth

Wide muscle blade – 6 teeth

| 27mm Width |
|------------|
| 3mm |
| 4mm |
| 5mm |
| 6mm |
| 7mm |
| 8mm |
| 9mm |
| 10mm |
| 12mm |

Extra Deep }

Retractor Frame

- Jointed Arm
- Maximum Spread 70mm
- Rigid Frame
- Extra Long Rack 140mm Spread



Hook Blade

| |
|------|
| 2mm |
| 3mm |
| 4mm |
| 5mm |
| 6mm |
| 7mm |
| 8mm |
| 9mm |
| 10mm |

Extra Deep }



Narrow Muscle Blade 4 Teeth

| 20mm Width |
|------------|
| 3mm |
| 4mm |
| 5mm |
| 6mm |
| 7mm |
| 8mm |
| 9mm |
| 10mm |
| 12mm |

Extra Deep }





Website: www.lithosmed.com

Email: Lithosmed@gmail.com

Telephone: +2347053666407

McCULLOCH RETRACTORS SET



Toothed Blade

Thin Muscle Blade 2 Teeth

Extra Deep {

| |
|------|
| 2mm |
| 3mm |
| 4mm |
| 5mm |
| 6mm |
| 7mm |
| 8mm |
| 9mm |
| 10mm |

| 17mm Width |
|------------|
| 3mm |
| 4mm |
| 5mm |
| 6mm |
| 7mm |
| 8mm |





MICRO DISCETOMY SET

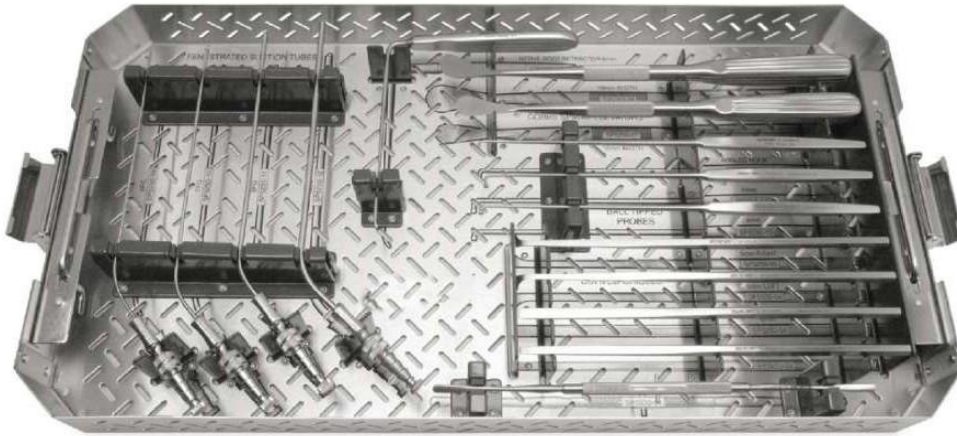

McCulloch Style Instrument Set with container
Complete set consisting of:

| Qty | Description |
|-----|--|
| 1 | McCulloch Spinal Hook, 4mm Tip-23cm/9” length |
| 1 | McCulloch Spinal Probe, 4mm Tip-23cm/9” length |
| 1 | McCulloch Spinal Probe,6mm Tip-23cm/9” length |
| 1 | Cobb Spinal Elevator, 12mm Width-26cm/10 ^{1/4} ” length |
| 1 | Cobb Spinal Elevator,19cm Width-26cm/10 ^{1/4} ” length |
| 1 | Spinal Osteotome,4mmWidth-22cm/8 ^{1/2} ” length |
| 1 | Spinal Osteotome,6mm Width-22cm/8 ^{1/2} ” length |
| 1 | ‘Hockey Stick’ Chisel,5mm Width-22cm/8 ^{1/2} ” length, curved right |
| 1 | ‘Hockey Stick’ Chisel,5mm Width-22cm/8 ^{1/2} ” length, curved left |
| 1 | Elevator Double Ended,24cm/9 ^{3/4} ” length |
| 1 | McCulloch Suction Tube, Fenestrated tip, 23cm/9” length, 6FG, 2.0mm |
| 1 | McCulloch Suction Tube, Fenestrated tip, 23cm/9” length, 7FG. 2.3mm |
| 1 | McCulloch Suction Tube, Fenestrated tip, 23cm/9” length, 9FG 3.0mm |
| 1 | McCulloch Suction Tube, Fenestrated tip,23cm/9” length, 12FG 4.0mm |
| 1 | McCulloch Nerve Root Retractor,90 ⁰ angled, 6mm tip, 12.5cm/5” working length |





Website: www.lithosmed.com

Email: Lithosmed@gmail.com

Telephone: +2347053666407

McCulloch Style Spinal Hook/Probe

23cm/9" length

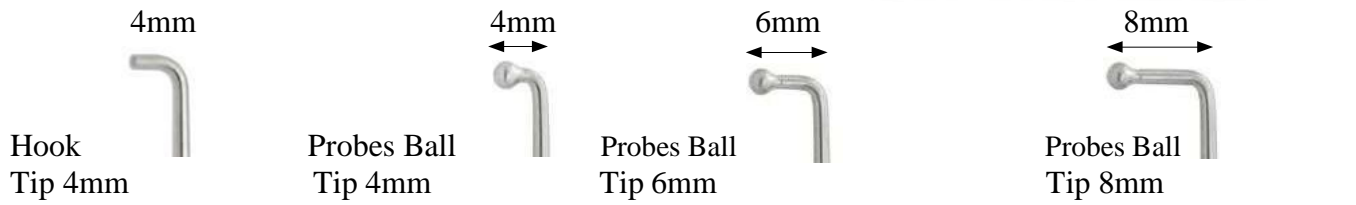

Cobb Spinal Elevator

26cm/10^{1/4}" length

| Width | |
|-------|------|
| 12mm | 19mm |



Spinal Osteotome

22cm/8^{1/2}" length

| Width | |
|-------|-----|
| 4mm | 6mm |



Hockey Stick Chisel

22cm/8^{3/4}" length
5mm width



Elevator Double Ended

24cm/9^{3/4}" length





Website: www.lithosmed.com

Email: Lithosmed@gmail.com

Telephone: +2347053666407

McCulloch Suction Tude

23cm/9" length

Fenestrated Tip



| Diameter | 2.0mm | 2.3mm | 3.0mm | 4.0mm |
|----------|-------|-------|-------|-------|
| FG | 6FG | 7FG | 9FG | 12FG |

McCulloch Nerve Root Retractor

- 12.5cm/5" length
- 90° angled
- 6mm tip



BLACK BELT CERVICAL RETRACTOR SET



An advanced cervical retractor system suitable for both anterior and posterior cervical surgery but with attachments for micro discectomy surgery.

A complete set of Cervical Black Belt Retractor consist of;

| Qty | Description |
|-----|--------------------------------------|
| 1 | Retractor Frame RIGHT |
| 1 | Retractor Frame LEFT |
| 1 | Retractor Frame OFFSET |
| 2 | Blade Inserter Clamps |
| 14 | Prolonged Blades 34mm-70mm |
| 14 | Blunt Blades 34mm-70mm |
| 12 | Two Level Prolonged Blades 40mm-55mm |
| 6 | Two Level Blunt Blades 40mm-55mm |
| 1 | Container |

Extended Black belt Cervical Retractor

Consisting of;
Standard Black Belt in addition with Micro Discectomy Attachment

| Qty | Description |
|-----|-----------------------------|
| 1 | Micro Discectomy attachment |
| 1 | Spike Blade |
| 1 | T-Shaped Blade |
| 1 | Inner Spine Ligament Blade |
| 1 | Pronged Blade 85mm Depth |

Coloured Titanium Extended “Black Belt” Cervical Retractor System

Complete Set Consisting of:

| Qty | Description |
|-----|--------------------------------------|
| 1 | Retractor Frame RIGHT |
| 1 | Retractor Frame LEFT |
| 1 | Retractor Frame OFFSET |
| 2 | Blade Insertion Clamp |
| 14 | Prolonged Blades 34mm |
| 14 | Blunt Blades 34mm-70mm |
| 12 | Two Level Prolonged Blades 40mm-55mm |
| 6 | Two Level Blunt Blade 40mm-5mm |



CERVICAL BLACK BELT RETRACTOR



Blades

- The blade shape is designed to resist climbing out of the surgical site
- The wider two- level blade have an extra bend near the tip, which follows the contour of the vertebrae for visualizing.
- Full jointed retractor arms
- Wide blade range
- Suitable for single or multi- level retractor

Spring Load Clamp Jaw

Blade Inserter Clamp

Thumb Screw



| | | | |
|--------------------------------|---------------------------------|---------------------------------------|--|
| 22mm Wide Blunt Blade | 22mm wide Prolonged Blade | 27mm Wide Two Level Blunt Blade | 27mm Wide Two level Prolonged Blade |
|--------------------------------|---------------------------------|---------------------------------------|--|

Clamp

- Spring loaded clamping jaws for easy blade engagement.
- Clamp handles create minimal visual obstruction.
- Blade/clamp assembly may be used for hand retraction.
- Clamps are quickly/ easily removed after retractor arms have securely engaged the blade



CERVICAL BLACK BELT RETRACTOR

Optional Narrow Cervical Blade



17mm wide optional narrow cervical blades
40mm-60mm Depth

Lumbar Micro Discectomy Attachments

With this set the standard Cervical Retractor becomes a Lumbar Microdiscectomy Retractor unit.
Complete set consisting of;

| Qty | Description |
|-----|----------------------------|
| 1 | Micro Disc attachment |
| 1 | Spike Blade |
| 1 | T-Shape Blade |
| 1 | Inner Spine Ligament Blade |
| 1 | Prolonged Blade 85mm depth |

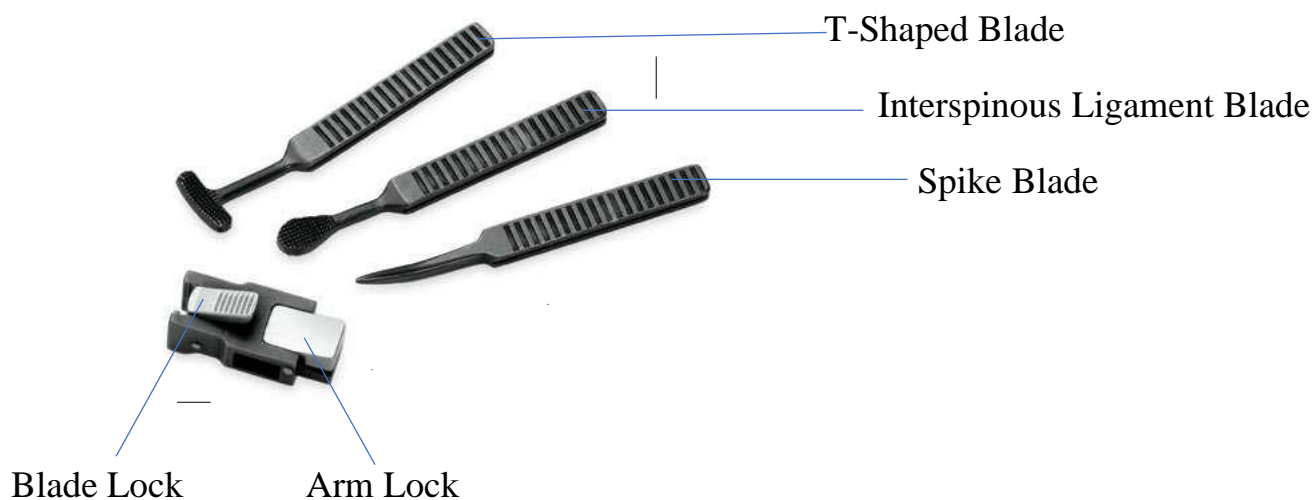

SUPER SLIDE II LAMINECTOMY RETRACTOR SET



A powerful retractor with a selection of blade depths which can be positioned anywhere along the retractor arms. It allows excellent exposures of the spine in pedicle screw and Laminectomy procedures.

Complete set consisting of:

| Qty | Description |
|-----|------------------------|
| 1 | Retractor Frame |
| 4 | Small Blades 2" depth |
| 4 | Medium Blades 3" depth |
| 4 | Large Blades 4" depth |
| 1 | Instrument container |

Super-Slide Retractor Extended Set

Include Components of basic set plus:

| Qty | Description |
|-----|--|
| 4 | Supplementary Blades 4 ³ / ₄ " depth |
| 2 | Unilateral Blade Heads |
| 2 | Unilateral T- Blades |

SUPER SLIDE II LAMINECTOMY RETRACTOR SET

Titanium Super-Slide Retractor Basic Set

Complete Set Consisting of:

| Qty | Description |
|-----|--------------------------------|
| 1 | Retractor Frame |
| 4 | Small Titanium Blade 2" depth |
| 4 | Medium Titanium Blade 3" depth |
| 4 | Large Titanium Blades 4" depth |
| 1 | Instrument Container |

Titanium Super-Slide Retractor Extended Set

Includes Components of titanium basic set plus:

| Qty | Description |
|-----|--|
| 4 | Supplementary Titanium Blades 4 3/4" depth |
| 2 | Unilateral Blade Heads |
| 2 | Unilateral Titanium T-blades |

Super Slide Retractor Blades

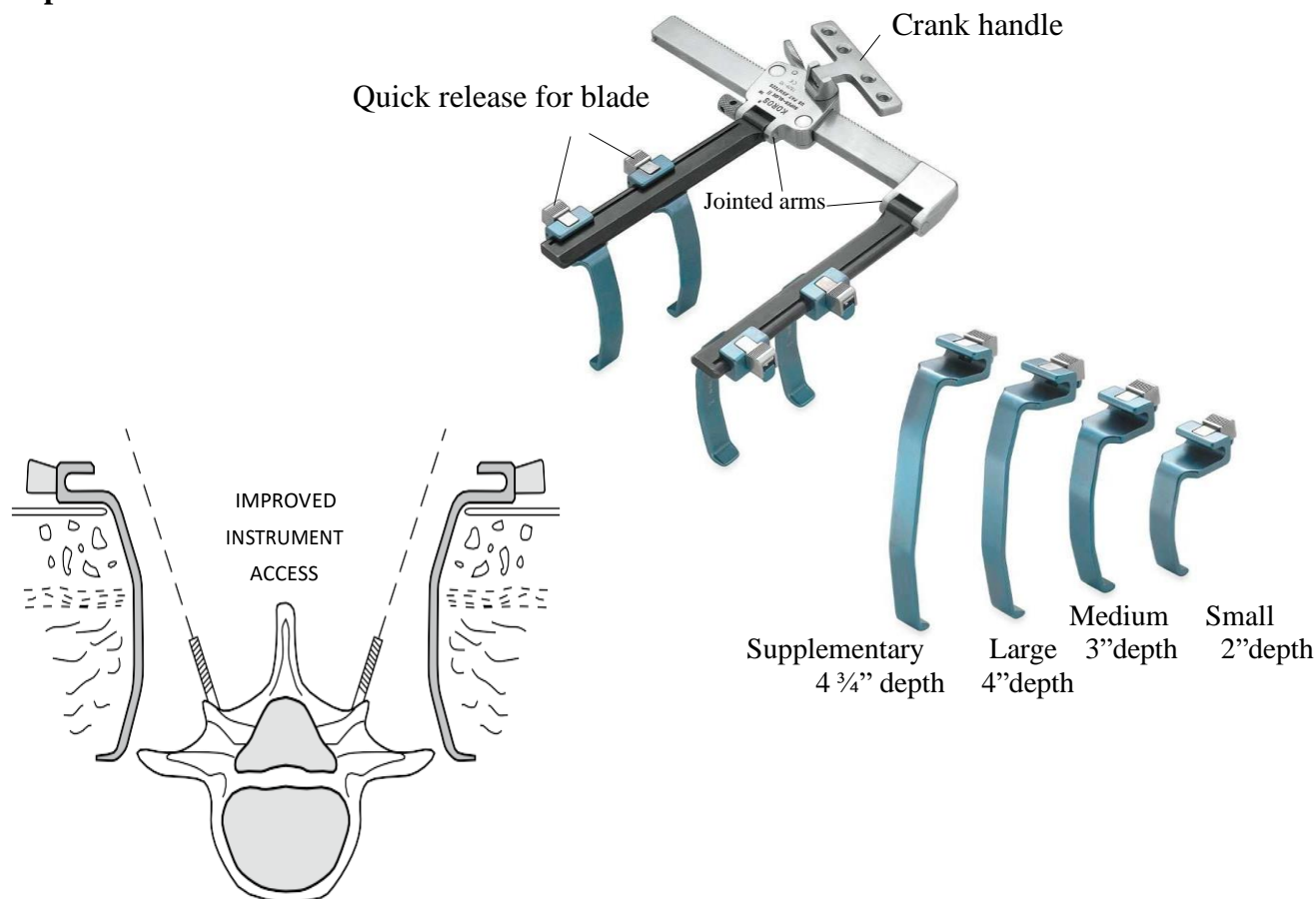

SUPER SLIDE II LAMINECTOMY RETRACTOR SET

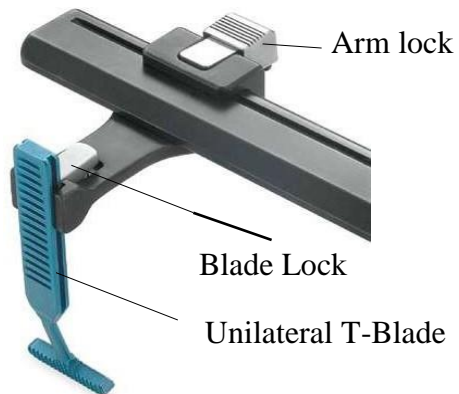

Unilateral Blade Attachment

- Blades lock into any chosen position along the retractor arms and may be changed at any time during surgery
- Arms lock allow the surgeon the choice of either attaching to the retractor arms then placing the unit into the wound or placing the blades into the wound then engaging the frame arms
- To obtain a unilateral exposure, use the unilateral blade attachment contained in extended set. The T-Blade is designed to attain a firm purchase on the spinous process.
- The T-Blade can be adjusted to the correct depth with the blade lock

CASPAR MICRO LUMBAR DISCECTOMY RETRACTOR SET

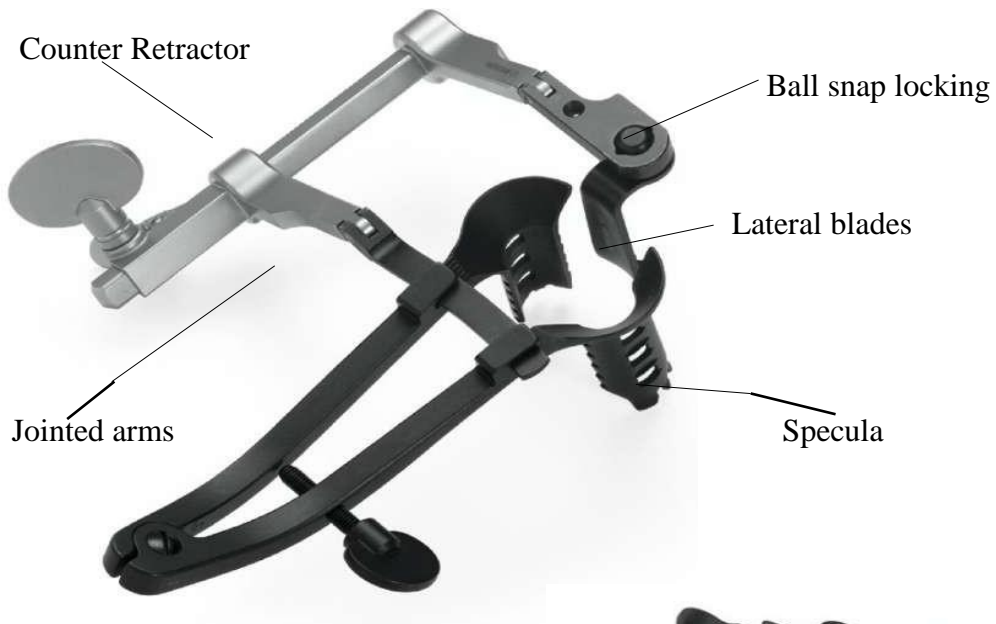

CASPAR MICRO LUMBAR DISCECTOMY RETRACTOR SET

Caspar Micro Discectomy Retractor

- This Retractor Set allows a micro surgery approach to lumbar disc
- Specula have a black surface finish to prevent glare
- Fenestrated blades on the specula reduce the risk of movement during surgery

Complete Set Consisting of:

| |
|--------------------------------|
| Counter Retractor Frame |
| Blade Ejector Forceps |
| Sterilizing Container |
| Tray Insert for Specula |
| Tray Insert for Lateral Blades |

| | Lateral Blades | | | | | Specula | | | | |
|-------|----------------|------|------|------|------|---------|------|------|------|-------|
| Depth | 40mm | 45mm | 50mm | 55mm | 60mm | 65mm | 75mm | 80mm | 85mm | 100mm |
| | | | | | | | | | | |



CASPAR MICRO LUMBAR DISCECTOMY RETRACTOR SET

Lateral Blades



Blade Ejector Forceps



Specula Ranges



CASPAR MICRO LUMBAR DISCECTOMY RETRACTOR SET

Caspar Micro Discectomy Retractor Frame



PICCOLINO MINI LUMBAR RETRACTOR SET

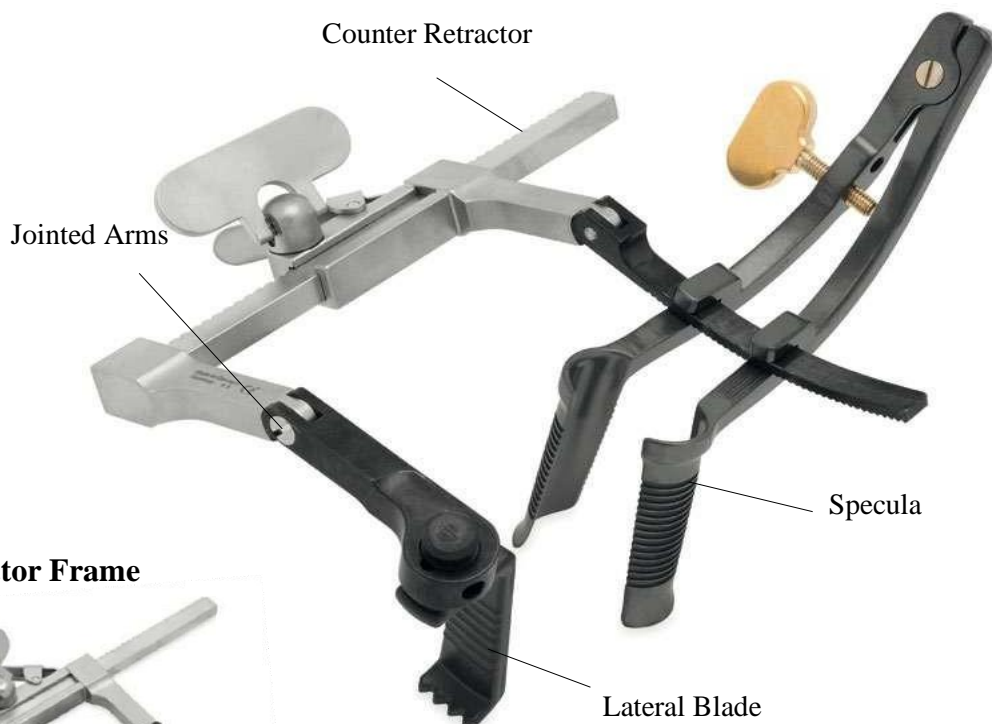

Counter Retractor Frame



Lateral Blades Radiolucent



Piccolino Mini Lumbar Retractor Set

- Micro Lumbar Surgery
- Lateral Blades are radiolucent
- Reduced 20mm incision

Specula



.....Bridging the gap to qual.

PICCOLINO MINI LUMBAR RETRACTOR SET

Complete Set

Consisting of the following:

| Lateral Blades | | | | | Specula | | | | |
|----------------|------|------|------|------|---------|------|------|------|------|
| Depth | 40mm | 45mm | 50mm | 55mm | 60mm | 65mm | 75mm | 80mm | 85mm |



BLACK BELT MICRO DISCECTOMY RETRACTOR SET

A specialist Retractor for Lumbar Micro Discectomy Surgery featuring;

- Jointed Retractor Arm
- Adjustable Blade Depth
- Range of prolonged Blades
- Powerful Ratchet action with quick release mechanism

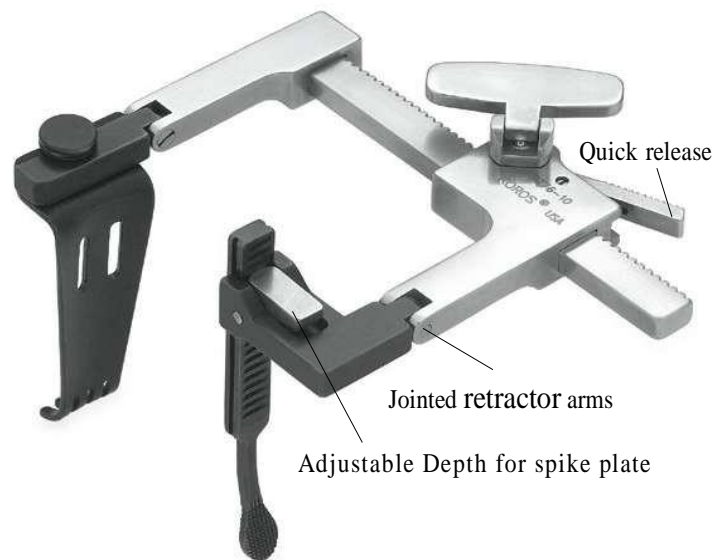
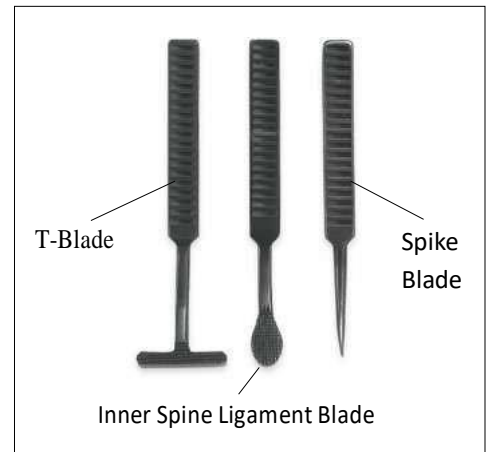

BLACK BELT MICRO DISCECTOMY RETRACTOR SET

Complete set Consist of:

| Qty | Description |
|-----|------------------------------|
| 1 | Retractor Frame |
| 1 | Blade Inserting Clamp |
| 1 | Spike Blade |
| 1 | T-Shape Blade |
| 1 | Inner Spine - Ligament Blade |
| 1 | Pronged Blade 40mm |
| 1 | Pronged Blade 45mm |
| 1 | Pronged Blade 50mm |
| 1 | Pronged Blade 60mm |
| 1 | Pronged Blade 70mm |
| 1 | Pronged Blade 85mm |
| 1 | Sterilizing Container |

LUMBAR SPINAL SET



LEVEL 3

LEVEL 2

LEVEL 1

Mercian introduce a new set of spinal instruments for lumbar spine surgery

The Mercian Lumbar Spine Set has three levels of instruments consisting of Bone Currettes and Nerve Root Retractors on the first level, Bone Nibblers and Hooks on the second level with the lower level consisting of KerrisonPunches 2mm to 5mm and Disc Ronguers.



LUMBAR SPINAL SET

Complete Set Consisting of the following;

Kerrison Puches—x4 Titanium

LEVEL 1

| Qty | Description |
|-----|--|
| 1 | Kerrison Titanium Punch, 2mm-20cm/8" length |
| 1 | Kerrison Titanium Punch, 3mm-20cm/8" length |
| 1 | Kerrison Titanium Punch, 4mm-20cmm/8" length |
| 1 | Kerrison Titanium Punch, 5mm-20cm/8" length |

Disc Ronguers---x6

| | |
|---|--|
| 1 | Cushing Disc Rongeur 2mm-18cm/7" Straight-18cm/7" Straight |
| 1 | Love-Gruenwald Disc Ronguer, 3mm-18cm/7" Straight |
| 1 | Spurling Disc Ronguer , 4mm-28cm/7" Straight |
| 1 | Love-Gruenwald Disc Ronguer, 3mm-18cm/7 Upward |
| 1 | Spurling Disc Ronguer 4mm-18cm/7" Upward |
| 1 | Wiliams Disc Ronguer, Toothed 1mm-23cm/9" Straight |

Bone Nibbler ---x6

LEVEL 2

| | |
|---|--|
| 1 | Leksell Bone Nibbler, 3mm Bite Size -24cm/9 ½" Length |
| 1 | Leksell Bone Nibbler, 5mm Bite Size -24cm/9 ½" Length |
| 1 | Jansen Bone Ronguer D/A, Curved 5mm Bite Size -18cm /7" Length |
| 1 | Zielke Disc Ronguer, 5mm Bite -21cm/8 ¼" Length |
| 1 | Rat Toothed Nibbler, 8mm Bite Size- 21cm/8 ¼" Length |
| 1 | Stille-Luer Bone Nibbler, 10mm Bite Size -22cm /8 ½" Length |

LUMBAR SPINAL SET

Bipolar Forceps

| | |
|---|--|
| 1 | Bayonet Bipolar Forceps, 1.5mm Tips X 23cm/9" Length |
|---|--|

Ball Tipped Probes--- x2

| | |
|---|---|
| 1 | Ball End Probe With 4mm Tip – 23cm/ 9" Length |
| 1 | Ball End Probe With 6mm Tip -23cm/9" Length |

Bone Curettes

LEVEL 3

| | |
|---|--|
| 1 | Curette, Straight, Cup Size 0 (2mm) -27cm/10" Length |
| 1 | Curette, Straight, Cup Size 1 (3mm) -27cm/10" Length |
| 1 | Curette, Angled Up, Cup Size 0 (2mm) -27cm/10" Length |
| 1 | Curette, Angled Up Size 1 (3mm) -27cm/10" Length |
| 1 | Bruns Curette, Straight, Cup 2 (4mm) -23cm/9" Length |
| 1 | Bruns Curette, Straight, Cup 1(5mm) -23cm/9" Length |
| 1 | Bruns Curette, Angled Up, Size 2 (4mm) -23/9" Length |
| 1 | Bruns Curette, Angled Up Size 1 (5mm) -23cm/ 9" Length |

Cobb Elevator---x2

| | |
|---|--|
| 1 | Cobbs Elevator, 13mm Width X 32cm/12 ¾" Length |
| 1 | Cobbs Elevator, 19mm Width X 32cm/12 ¾" Length |

Adson Hooks –x2

| | |
|---|--|
| 1 | Adson Sharp Hook 90 ⁰ 5mm Tip -20cm/" Length |
| 1 | Adson Blunt Hook 90 ⁰ 5mm Tip -20cm/8" Length |

Dissector --X2

| | |
|---|--|
| 1 | Macdonald Dissector – 23cm/9" Length |
| 1 | Watson Cheyne Dissector – 23cm/ 9 Length |

Nerve Root Retractor --X4

| | |
|---|---|
| 1 | Krayenbuhl Nerve Root Retractor – 21cm/8 ¼" Length |
| 1 | Krayenbuhl Nerve Root Retractor -24cm/9 ½" Length |
| 1 | Mcculloch Nerve Root Retractor 90 0 (Level 2) |
| 1 | Nerve Root Retractor With Suction – 31cm/12" Length |



BAYONET MICRO INSTRUMENTS

Yasargil Bayonet Micro Forceps

- Flat handled
- Blunt tips



| | 22.5cm/8 ^{1/2} " | 24cm/9 ^{1/2} " |
|-----------------|---------------------------|-------------------------|
| Tip Size | 1mm | 1mm |

Yasargil Bayonet Tumour Grasping Forceps

- Flat handled



Spoon Shaped Jaws Tip Size

| | |
|---------------|-----|
| 22.5cm/8 1/2" | 3mm |
| 22.5cm/8 1/2" | 5mm |



Flat Serrated Jaws Tip Size

| | |
|---------------|-----|
| 22.5cm/8 1/2" | 3mm |
| 22.5cm/8 1/2" | 5mm |



Curette Toothed Jaws Tip Size

| | |
|---------------|-----|
| 22.5cm/8 1/2" | 3mm |
| 22.5cm/ 1/2" | 5mm |



Bayonet Tumour Grasping Forceps

- Round bodied
- Flat serrated Jaws



| Length | Tip Size |
|---------|----------|
| 23cm/9" | 5mm |



BAYONET MICRO INSTRUMENTS

Bayonet Micro Forceps

- Round Bodied



| | | |
|-----------------|---|----------------|
| | 21cm/8¹/₄" | 23cm/9" |
| Tip Size | 1mm | 1mm |

Yasargil Bayonet Micro Needle Holder

- Flat handled
- Delicate 1mm Jaws



| | | |
|------------------|------------------|---------------------|
| | 23cm/9" | |
| | With Lock | Without Lock |
| Dimension | Straight | Curved |

Yasargil Bayonet Micro Scissors

- Flat handled
- 22.5cm/8" Length



Regular Blades



Straight



Curved

Vannas Fine Blades



Straight



Curved

Bayonet Micro Needle Holder

- Round Bodied
- Delicate 1mm Jaws



| | 21cm/8 ^{1/4} '' | 23cm/9'' |
|-----------|--------------------------|--------------|
| | With Lock | Without Lock |
| Dimension | Straight | Curved |

BIPOLAR FORCEP

Straight Bipolar Forceps



| Length | Tip Size | Dimension |
|--|----------|-------------|
| 16.5cm/6 ¹ / ₂ " | 0.7mm | Fine Tip |
| 19cm/7 ¹ / ₂ " | 1.0mm | Regular Tip |
| 26cm/10 ¹ / ₄ " | 2.0mm | |

—

—

—

Straight Bipolar Forceps Supergliss

- Non-Stick Tips



The material specially developed for SuperGliss non-stick forceps prevents overheating of the tips during coagulation

| Length | Tip Size | Dimension |
|--|----------|-------------|
| 18.5cm/7 ¹ / ₄ " | 0.7mm | Fine Tip |
| 20cm/8" | 1.0mm | Regular Tip |

—

—

Bayonet Bipolar Forceps

| Length | Tip Size |
|--------------------------------------|----------|
| 19cm/7 ¹ / ₂ " | 0.7mm |
| | 1.0mm |
| | 2.0mm |
| 23cm/9" | 0.7mm |
| 25cm/9 ³ / ₄ " | 1.2mm |



BAYONET FORCEP

Bayonet Bipolar Forceps SuperGliss

- Non-Stick Tip



The material specially developed for SuperGliss non-stick forceps prevents overheating of the tips during coagulation

| Length | Tip Size |
|--------------------------------------|----------|
| 20cm/8 ¹ / ₂ " | 0.7mm |
| 23cm/9" | 1.0mm |
| 25cm/9 ³ / ₄ " | 1.2mm |

Bayonet Bipolar Forceps

- 22.5cm/8 ³/₄" length
- Non-Stick tips
- Mallis 2 pin fitting



| Tip Size | 0.5mm | 0.7mm | 1.0mm | 1.3mm | 1.5mm | 2.0mm |
|----------|-------|-------|-------|-------|-------|-------|
| | | | | | | |

BIPOLAR CABLES

Bipolar Lead

- Fitting Block End Forceps
- Banana Plug Valley Machine Fitting
- 4.5 Meter Length



Bipolar Lead

- Fitting Block End Forceps
- Erbe BM780 Machine Fitting
- 4.5 Meter length



Bipolar Lead

- Fitting American 2-pin Forceps
- Banana Plug Valleylab Machine Fitting
- 4.5 meter length



MISC INSTRUMENTS

Slim & Square Ended Wire Pliers

- 19cm/7 1/2" length

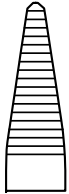

Slim Nose

Square Ended

Serrated jaw

Muller Claus Wire Cutters

- Tungsten carbide edges
- 18cm/7" length
- Cuts wire up to 2mm Ø

- 22cm/8 3/4" length
- Cuts wire up to 3mm Ø



Combined Wire Cutters & Plier

- 18 cm/7" length
- Suitable for wire up to 1.6mm Ø
- Parallel closing jaws



MISC INSTRUMENTS

Bolt Cutters With Dismantable Arm

Max. Cap 6.3mm pins

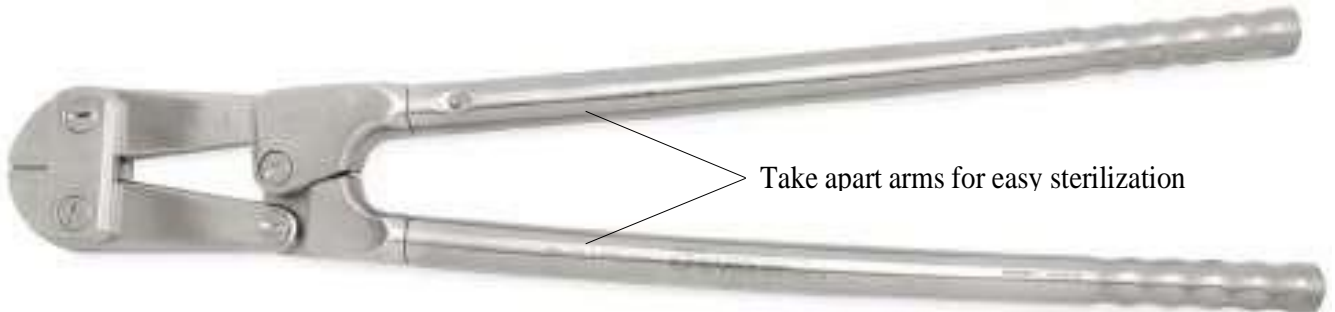

Must be in conjunction with a Rod Holder

Orthopaedic Locking Pliers

- Hardened Jaws

| Length | |
|-------------------------|--------|
| 18cm/7" | Small |
| 20cm/8" | Medium |
| 24cm/9 ^{1/2} " | Large |



Needle Nosed Locking Pliers

| Length | |
|--------------------------|--------|
| 22cm/8 ^{3/4} " | Small |
| 25cm/9 ^{3/4} " | Medium |
| 30cm/11 ^{3/4} " | Large |



A very useful instrument for orthopedic surgery allowing the surgeon to securely clamp on to wires and implants.

MISC INSTRUMENTS

Measuring Caliper

- 25cm/ 10" length
- Measuring range 0 to 50mm



Castroviejo Caliper

- 7cm/2 ¾" length
- Measuring range 3mm to 25mm



Vernier Caliper

- 22.5cm/9" length
- Measuring range 15cm

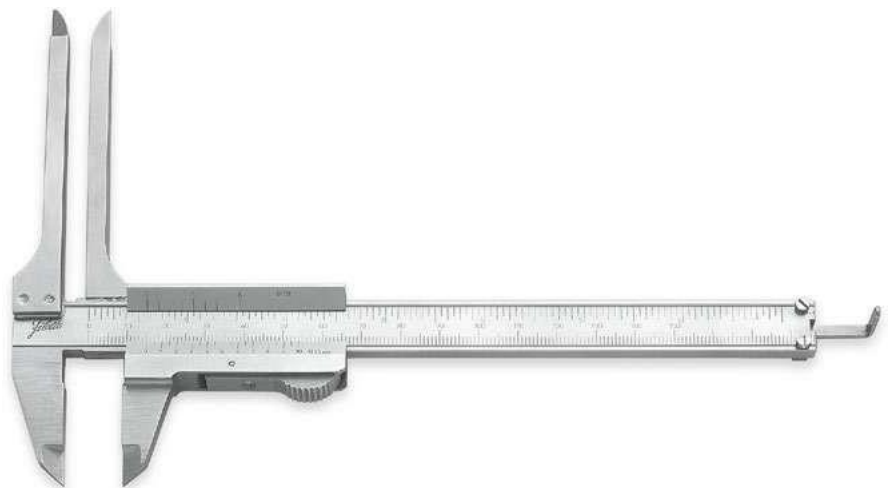

MISC INSTRUMENTS

Depth Gauge

- Measuring depth 50mm



Depth Gauge

- Measuring depth 70mm



Direct Reading Depth Gauge

- 23cm length
- Measuring depth up to 40mm



Frazier Suction Tube

- 17cm 6 3/4" length



| Diameter | 2.0mm | 2.3mm | 2.7mm | 3.0mm | 3.3mm | 3.7mm | 4.0mm |
|----------|-------|-------|-------|-------|-------|-------|-------|
| FG | 6FG | 7FG | 8FG | 9FG | 10FG | 11FG | 12FG |

MISC INSTRUMENTS

Frazier Suction Tube

- 23cm/9" length



| Diameter | 2.0mm | 2.3mm | 2.7mm | 3.0mm | 3.3mm | 3.7mm | 4.0mm |
|----------|-------|-------|-------|-------|-------|-------|-------|
| FG | 6FG | 7FG | 8FG | 9FG | 10FG | 11FG | 12FG |

Bayonet Dissecting Forceps



| Length | Tip Size |
|------------------------------|----------|
| 19cm/7^{1/2}" | 1mm |
| | 2mm |
| 21cm/8^{1/2}" | 1mm |
| | 2mm |



SPINE SURGERY INSTRUMENTS

PRODUCT CATALOGUE



LithosMed